

For updated version, please click on
<http://ocw.ump.edu.my>

Mechanics of Materials

Project 2 - 2

by

Dr Nanang Fatchurrohman
Faculty of Manufacturing Engineering
fatchurrohman@ump.edu.my



Mechanics of Materials: N. Fatchurrohman

1. 3D IN CATIA

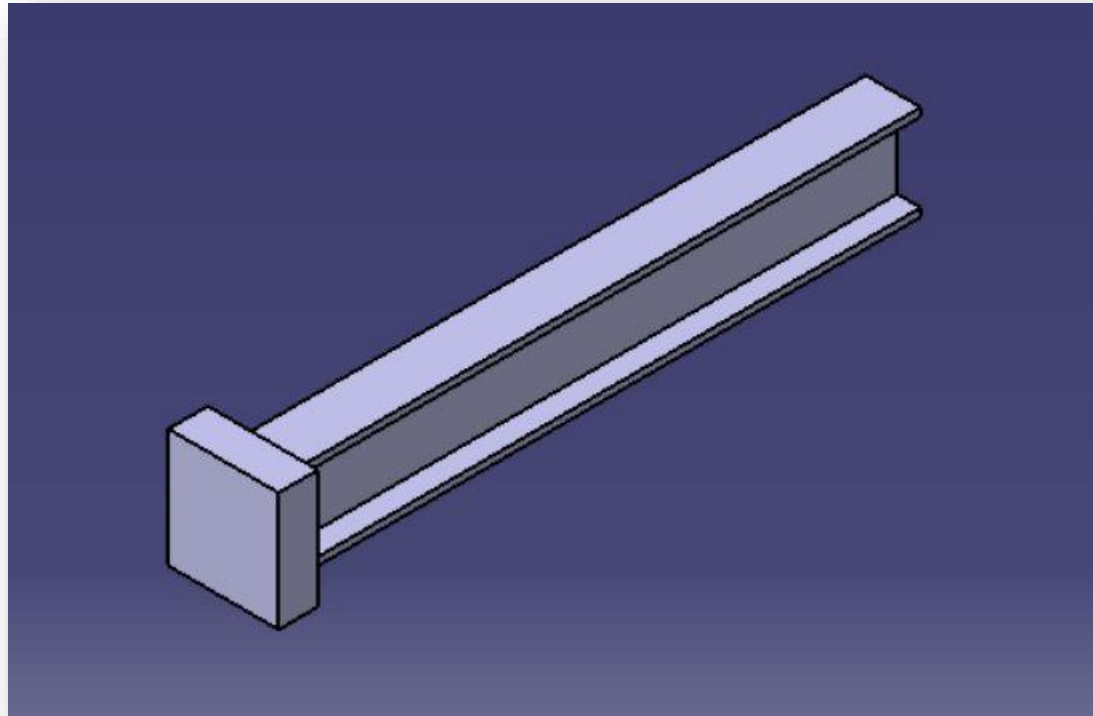

Figure 2. Isometric view of the I-beam





Figure 3 Front view of the I-beam

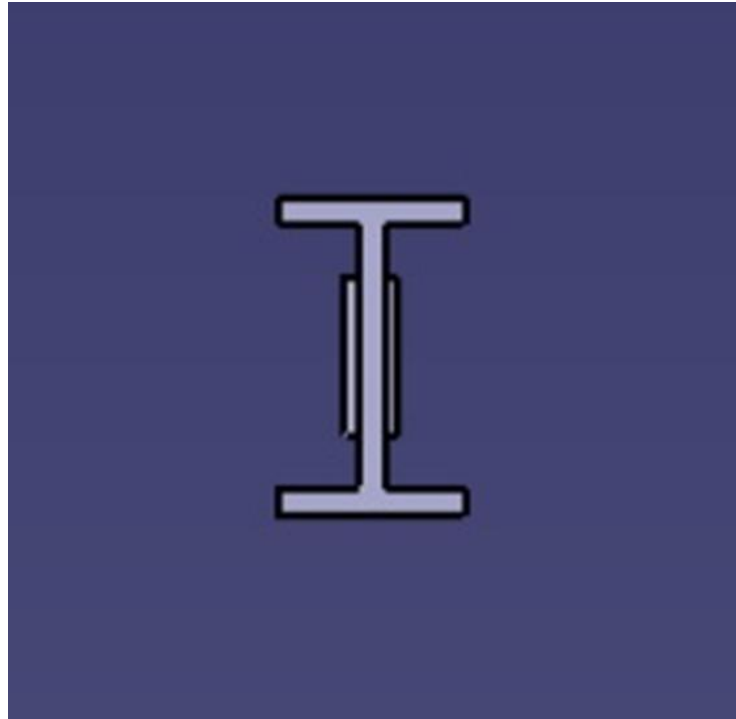

Figure 4 Side view of I-beam

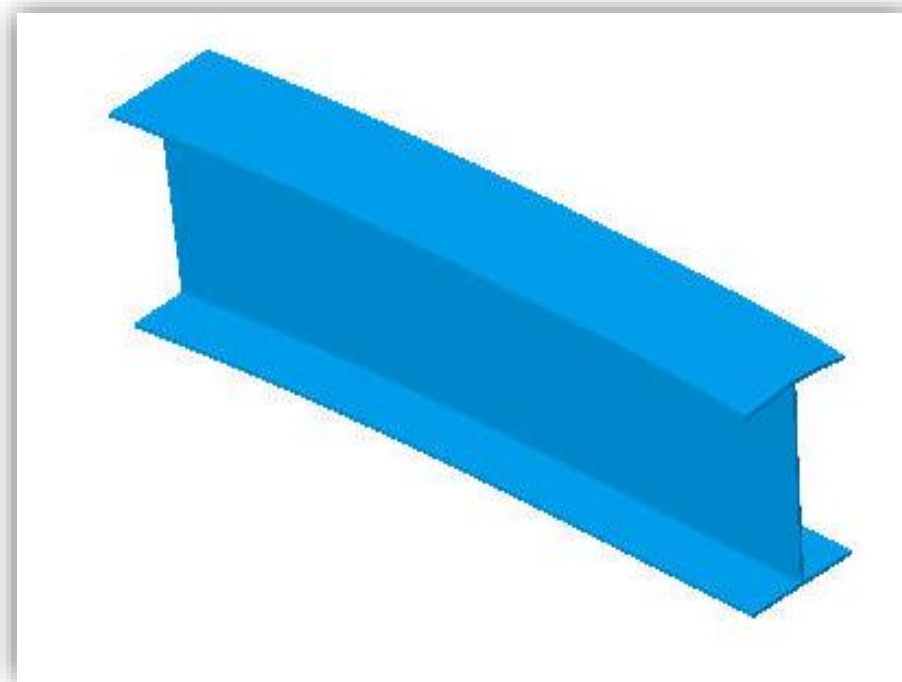

Figure 5. Bending Test

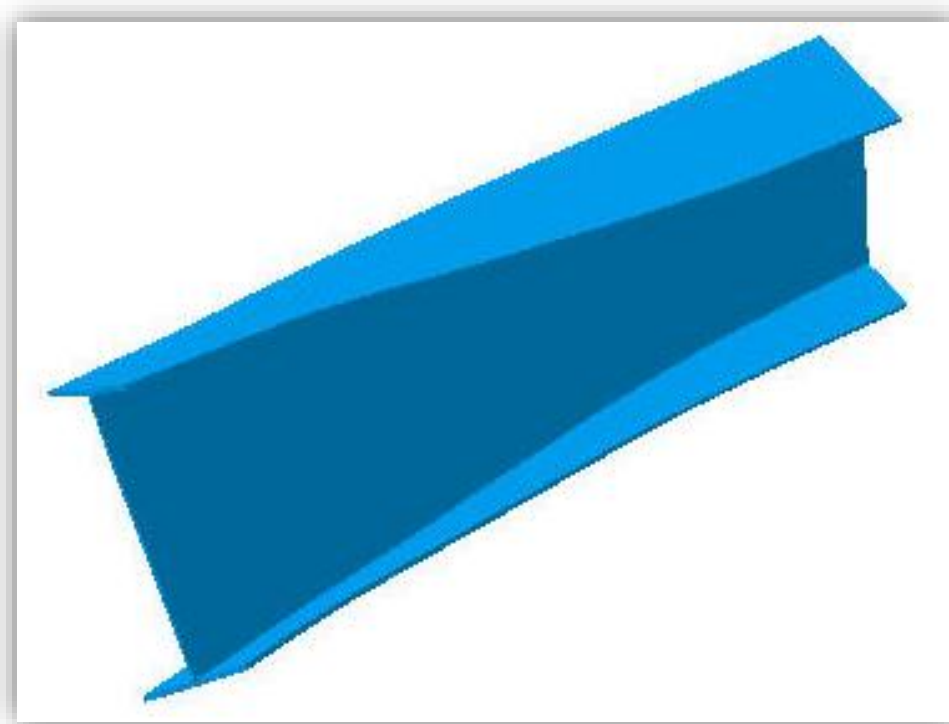

Figure 6. Torsion test

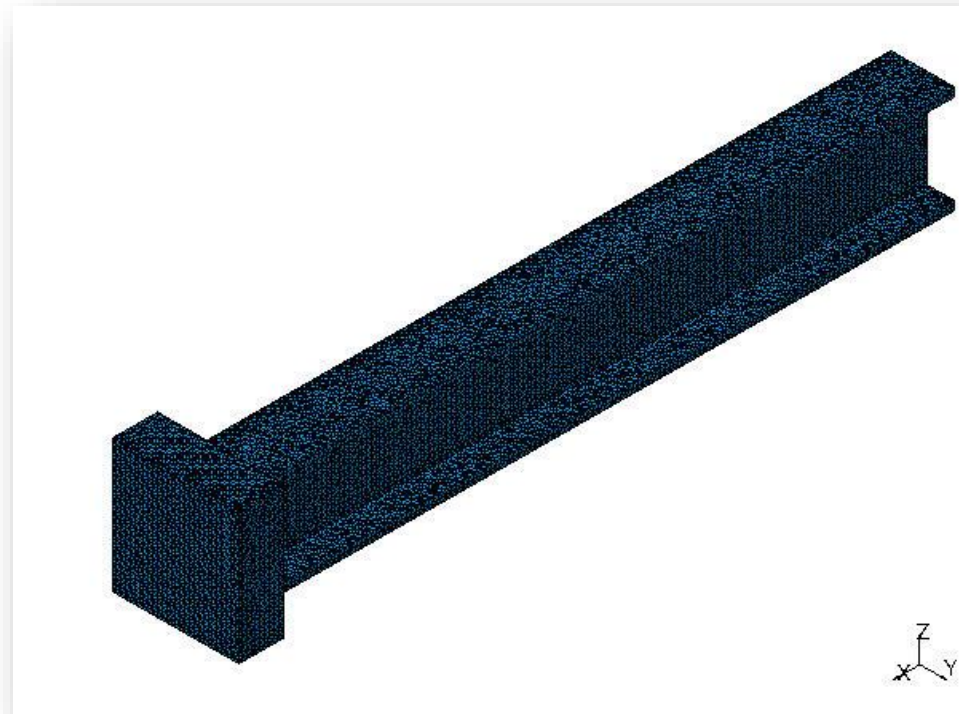

Figure 7 Tension test

II. Main Free Body Diagram

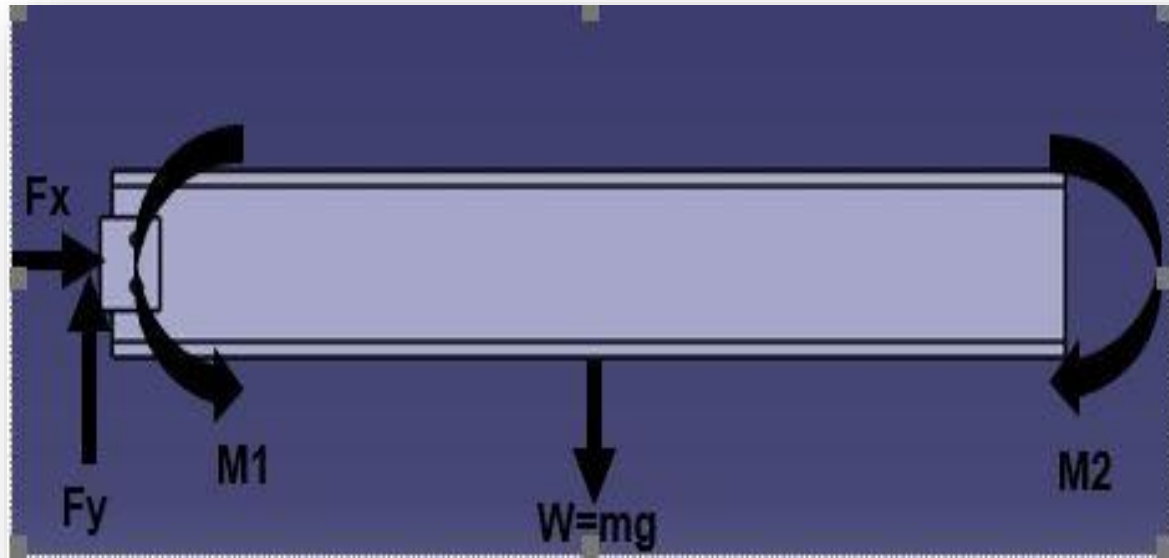

Figure 8 FBD

II. Bending

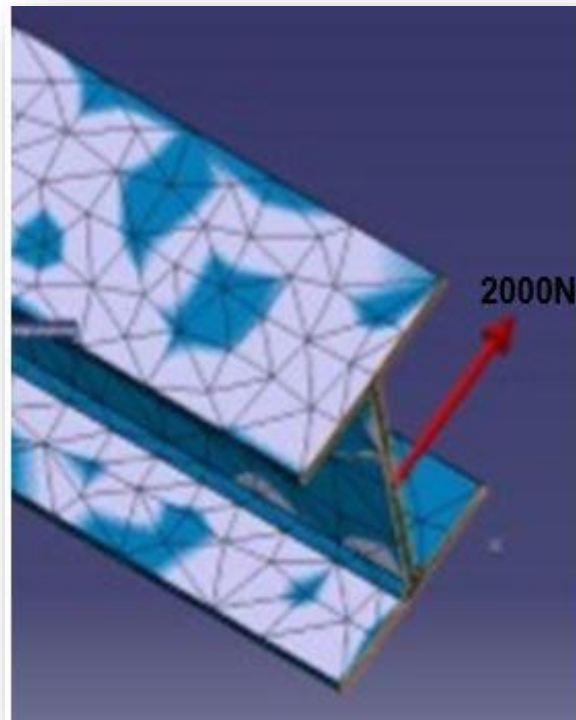

Figure 9 Bending's Force

III. Torsion

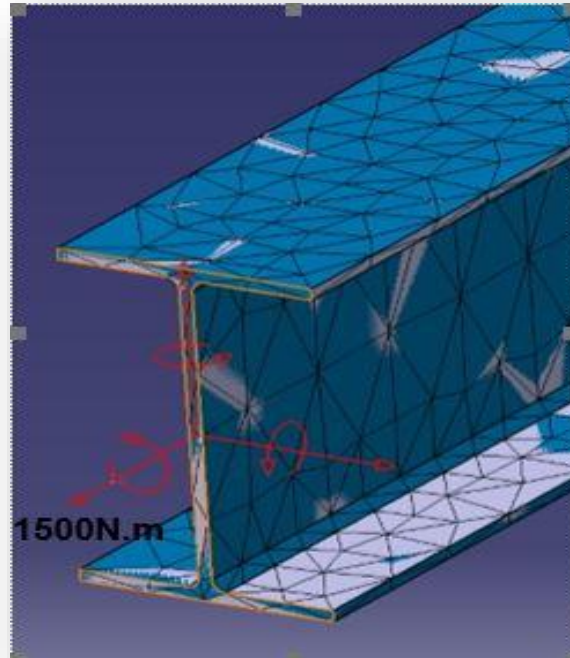

Figure 10 Torsional Force