

# UNIVERSITY PHYSICS

## Chapter 9 CURRENT AND RESISTANCE

PowerPoint Image Slideshow

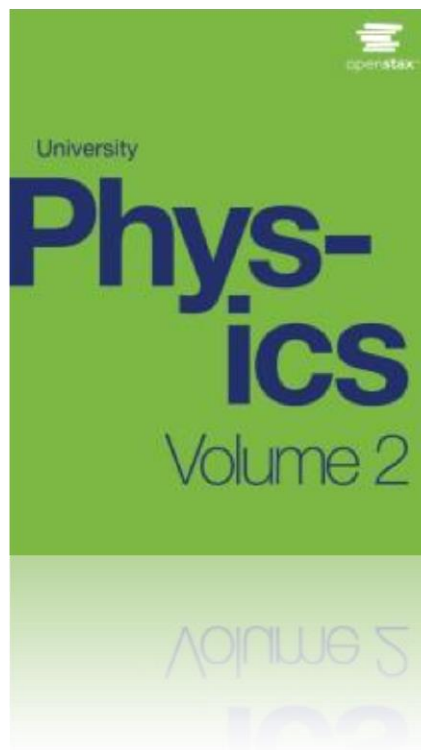

## FIGURE 9.1



Magnetic resonance imaging (MRI) uses superconducting magnets and produces high-resolution images without the danger of radiation. The image on the left shows the spacing of vertebrae along a human spinal column, with the circle indicating where the vertebrae are too close due to a ruptured disc. On the right is a picture of the MRI instrument, which surrounds the patient on all sides. A large amount of electrical current is required to operate the electromagnets (credit right: modification of work by “digital cat”/Flickr).

## FIGURE 9.2

Current = flow of charge

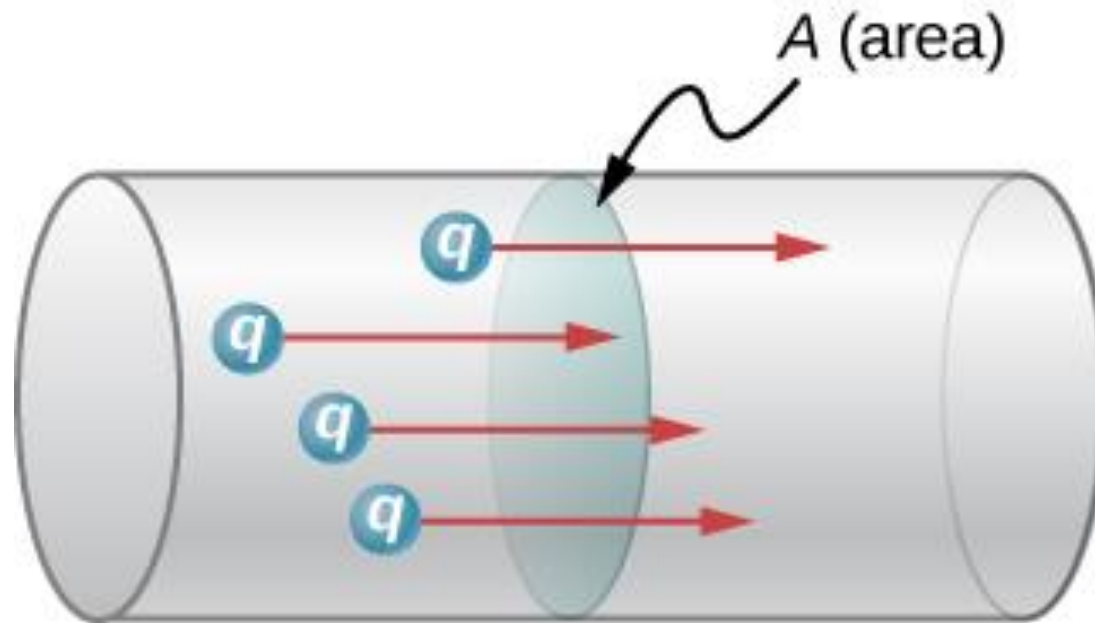

The rate of flow of charge is current. An ampere is the flow of one coulomb of charge through an area in one second. A current of one amp would result from  $6.25 \times 10^{18}$  electrons flowing through the area  $A$  each second.

## FIGURE 9.3

$Q(t)$  vs.  $t$

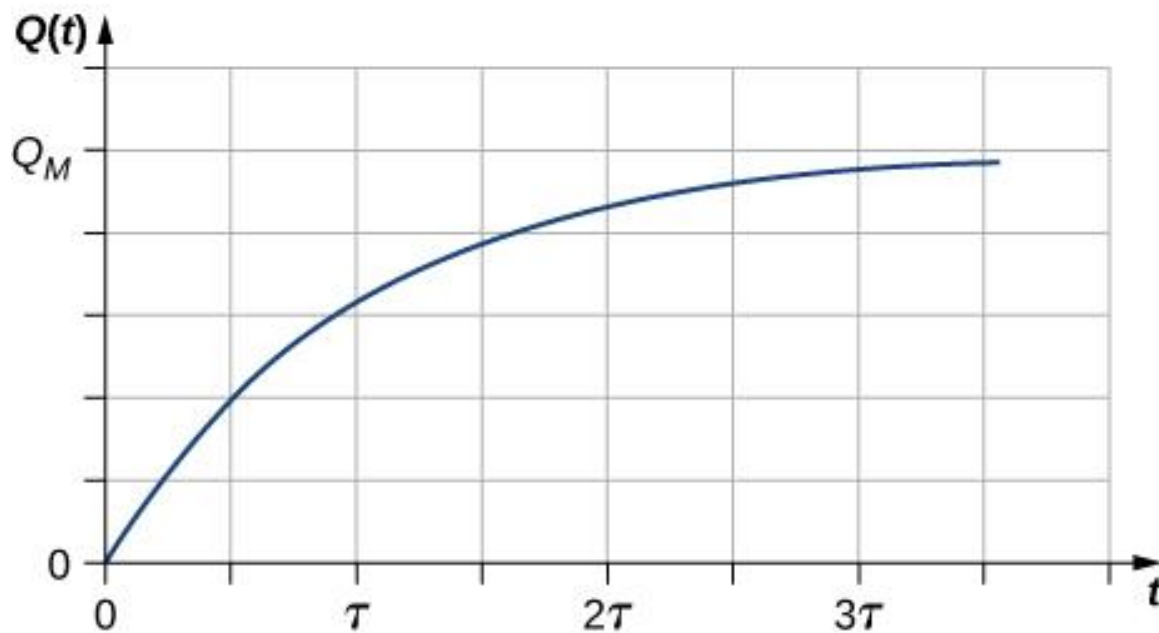

A graph of the charge moving through a cross-section of a wire over time.

## FIGURE 9.4

$I(t)$  vs.  $t$

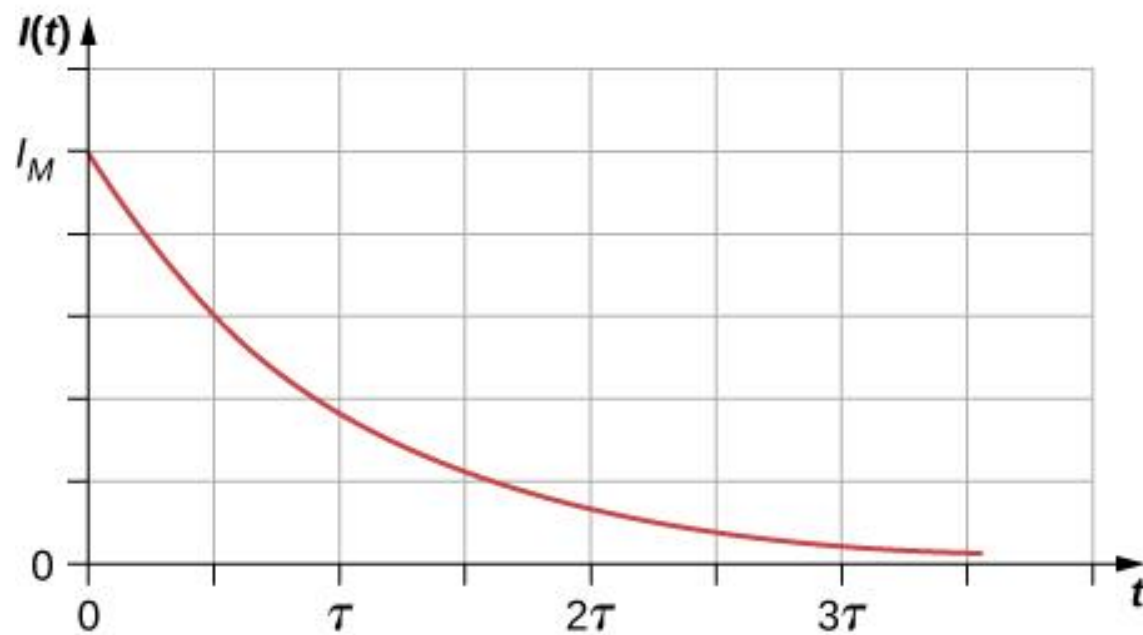

A graph of the current flowing through the wire over time.

# FIGURE 9.5

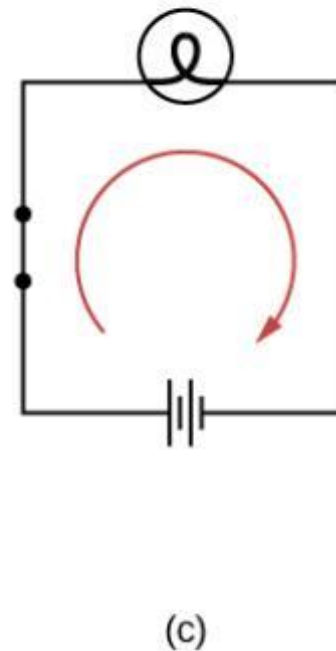
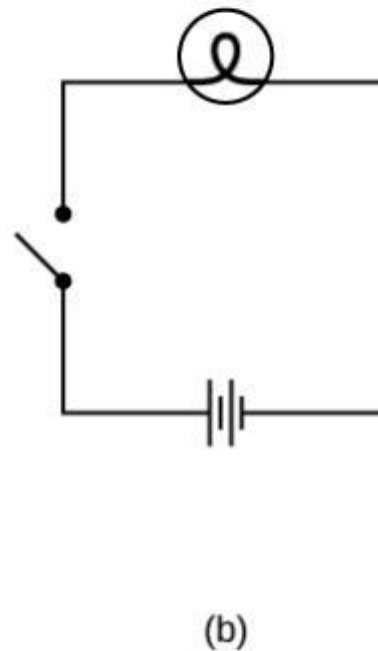
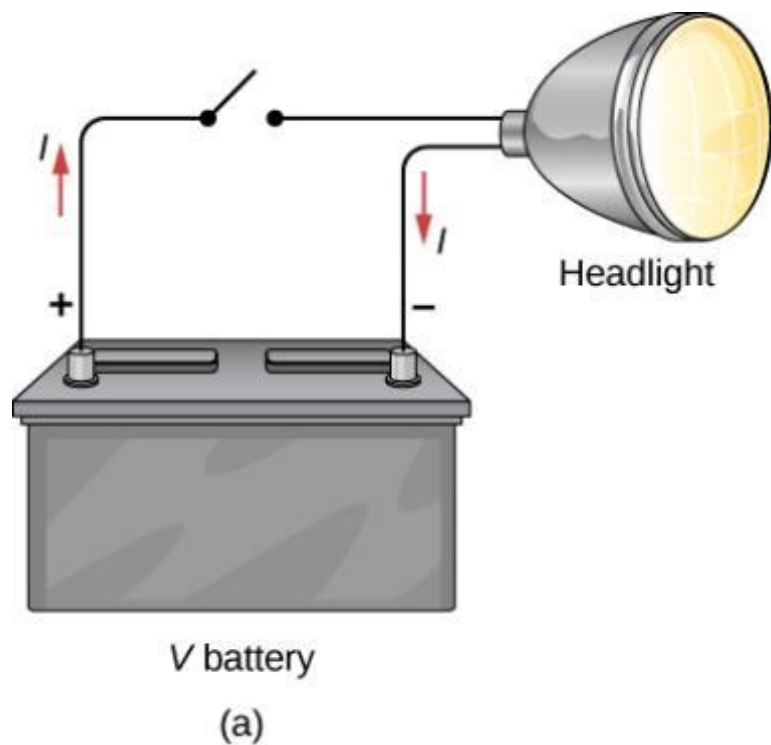

- (a) A simple electric circuit of a headlight (lamp), a battery, and a switch. When the switch is closed, an uninterrupted path for current to flow through is supplied by conducting wires connecting a load to the terminals of a battery.
- (b) In this schematic, the battery is represented by parallel lines, which resemble plates in the original design of a battery. The longer lines indicate the positive terminal. The conducting wires are shown as solid lines. The switch is shown, in the open position, as two terminals with a line representing a conducting bar that can make contact between the two terminals. The lamp is represented by a circle encompassing a filament, as would be seen in an incandescent light bulb.
- (c) When the switch is closed, the circuit is complete and current flows from the positive terminal to the negative terminal of the battery.

## FIGURE 9.6

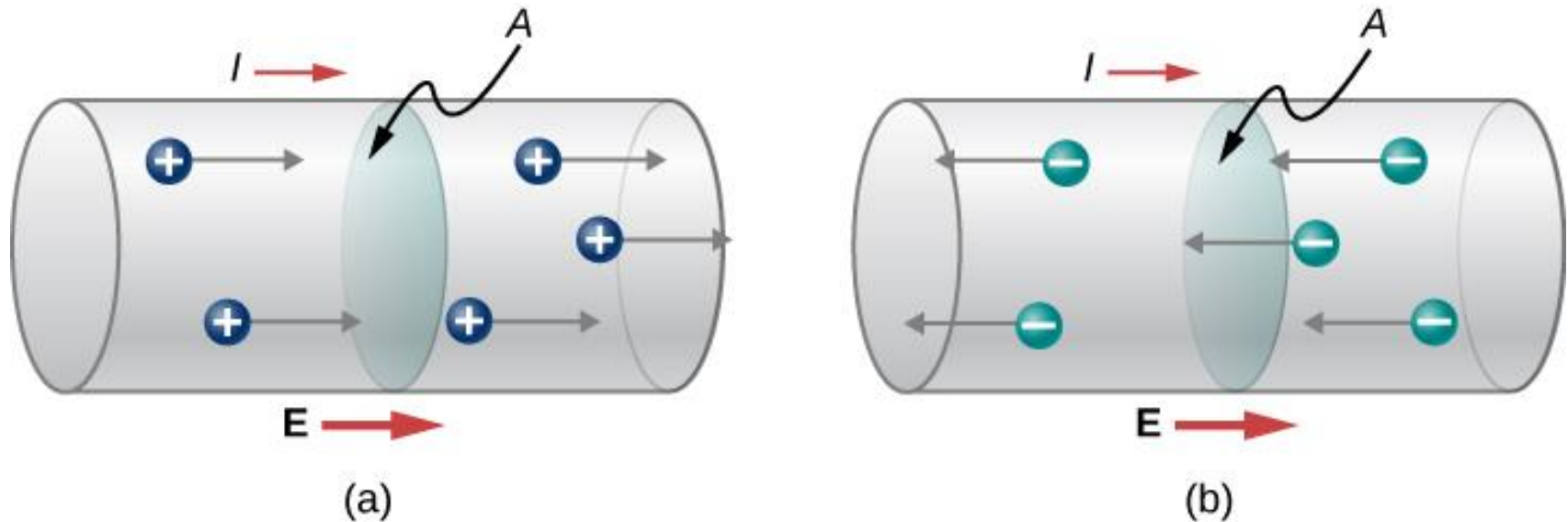

Current  $I$  is the rate at which charge moves through an area  $A$ , such as the cross-section of a wire. Conventional current is defined to move in the direction of the electrical field.

- (a) Positive charges move in the direction of the electrical field, which is the same direction as conventional current.
- (b) Negative charges move in the direction opposite to the electrical field. Conventional current is in the direction opposite to the movement of negative charge. The flow of electrons is sometimes referred to as electronic flow.

## FIGURE 9.7

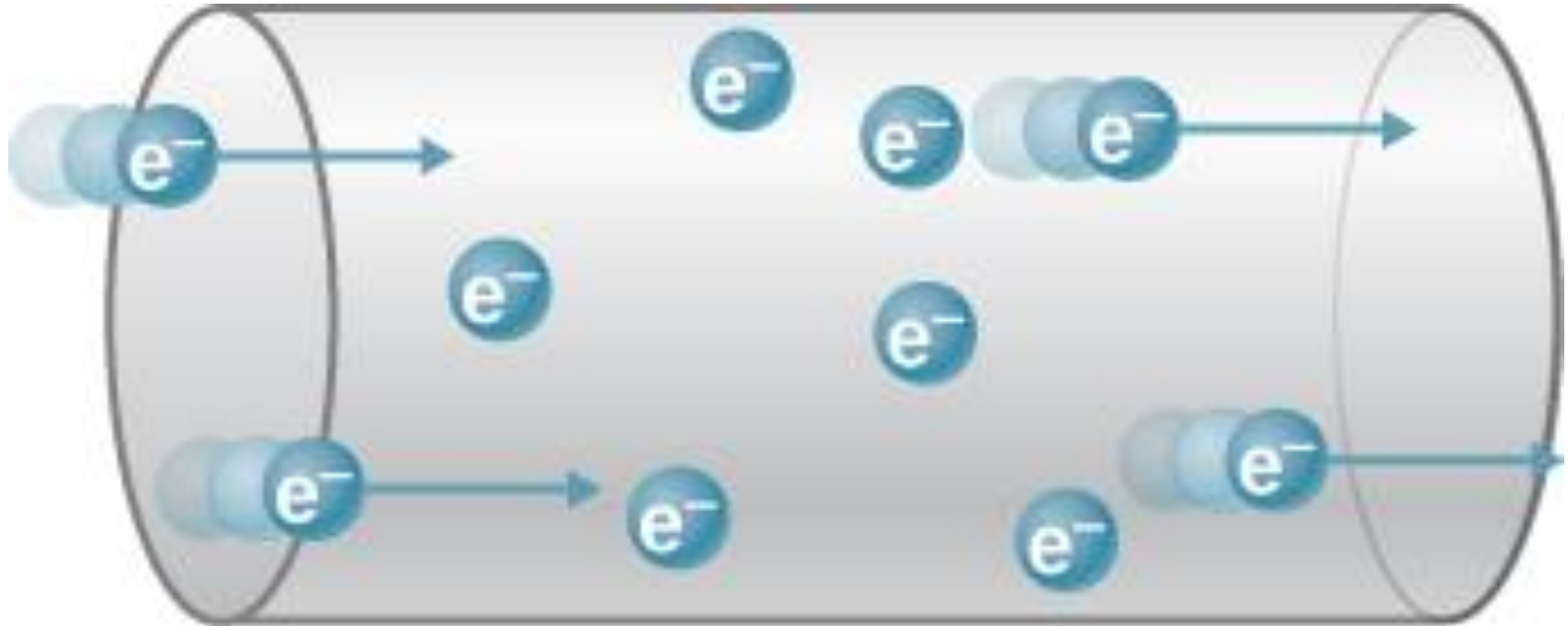

When charged particles are forced into this volume of a conductor, an equal number are quickly forced to leave. The repulsion between like charges makes it difficult to increase the number of charges in a volume. Thus, as one charge enters, another leaves almost immediately, carrying the signal rapidly forward.



## FIGURE 9.8

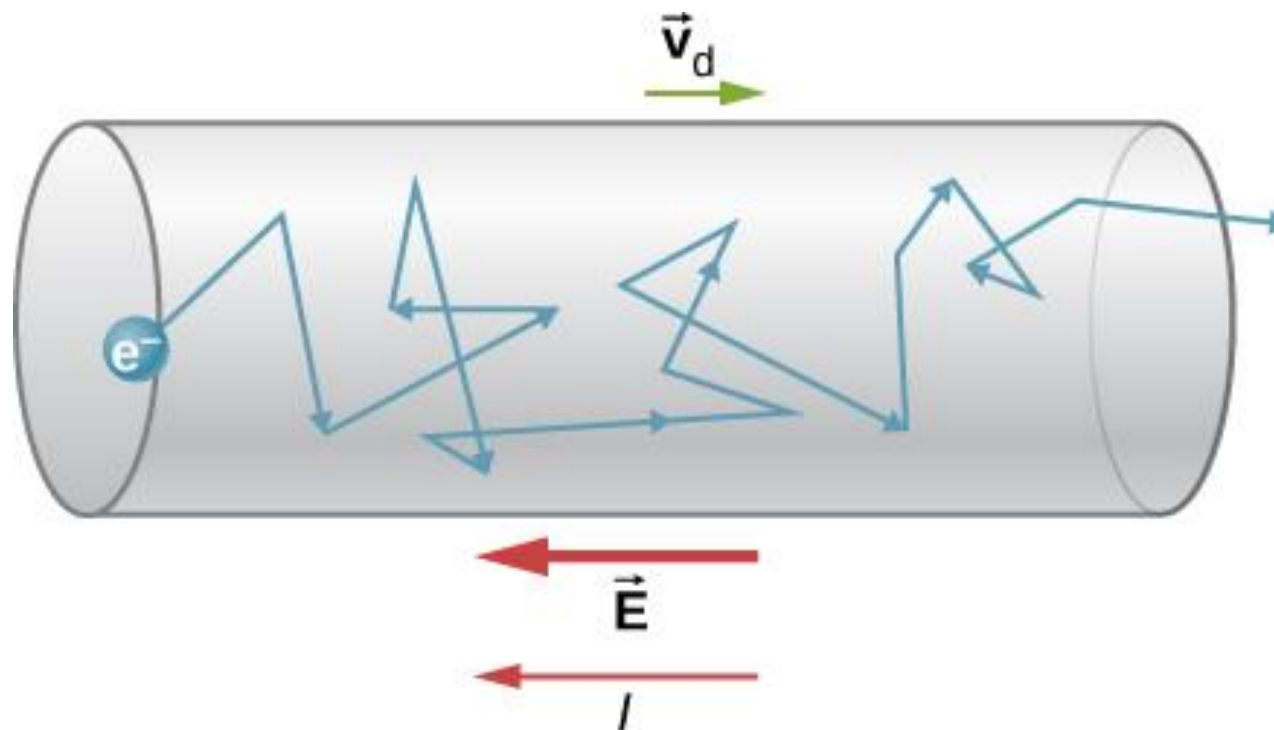

Free electrons moving in a conductor make many collisions with other electrons and other particles. A typical path of one electron is shown. The average velocity of the free charges is called the drift velocity  $\vec{v}_d$  and for electrons, it is in the direction opposite to the electrical field. The collisions normally transfer energy to the conductor, requiring a constant supply of energy to maintain a steady current.

## FIGURE 9.9

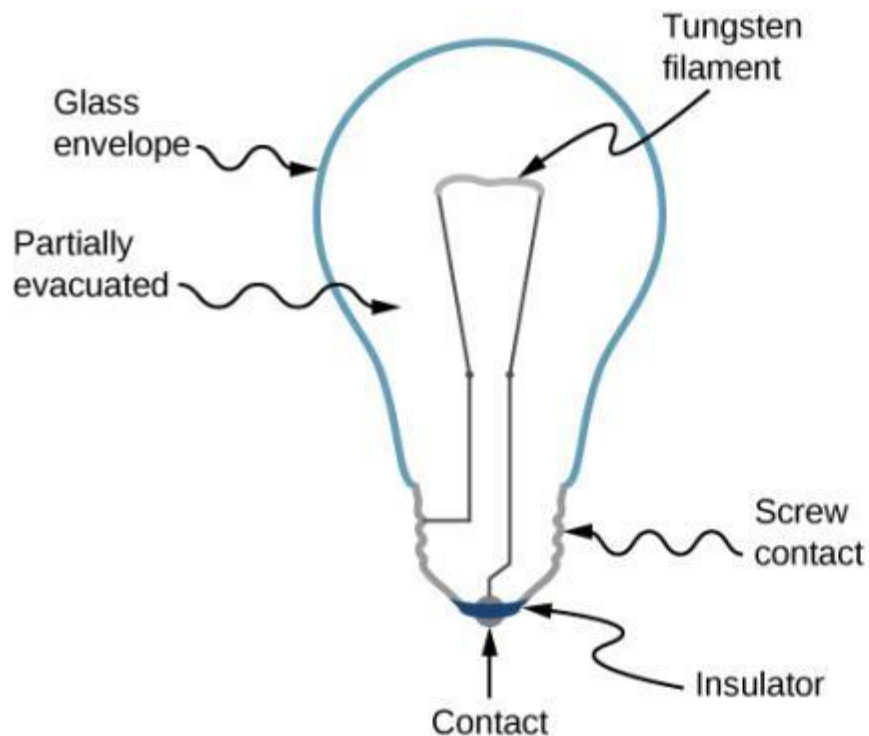

The incandescent lamp is a simple design. A tungsten filament is placed in a partially evacuated glass envelope. One end of the filament is attached to the screw base, which is made out of a conducting material. The second end of the filament is attached to a second contact in the base of the bulb. The two contacts are separated by an insulating material. Current flows through the filament, and the temperature of the filament becomes large enough to cause the filament to glow and produce light. However, these bulbs are not very energy efficient, as evident from the heat coming from the bulb. In the year 2012, the United States, along with many other countries, began to phase out incandescent lamps in favor of more energy-efficient lamps, such as light-emitting diode (LED) lamps and compact fluorescent lamps (CFL) (credit right: modification of work by Serge Saint).

**FIGURE 9.10**

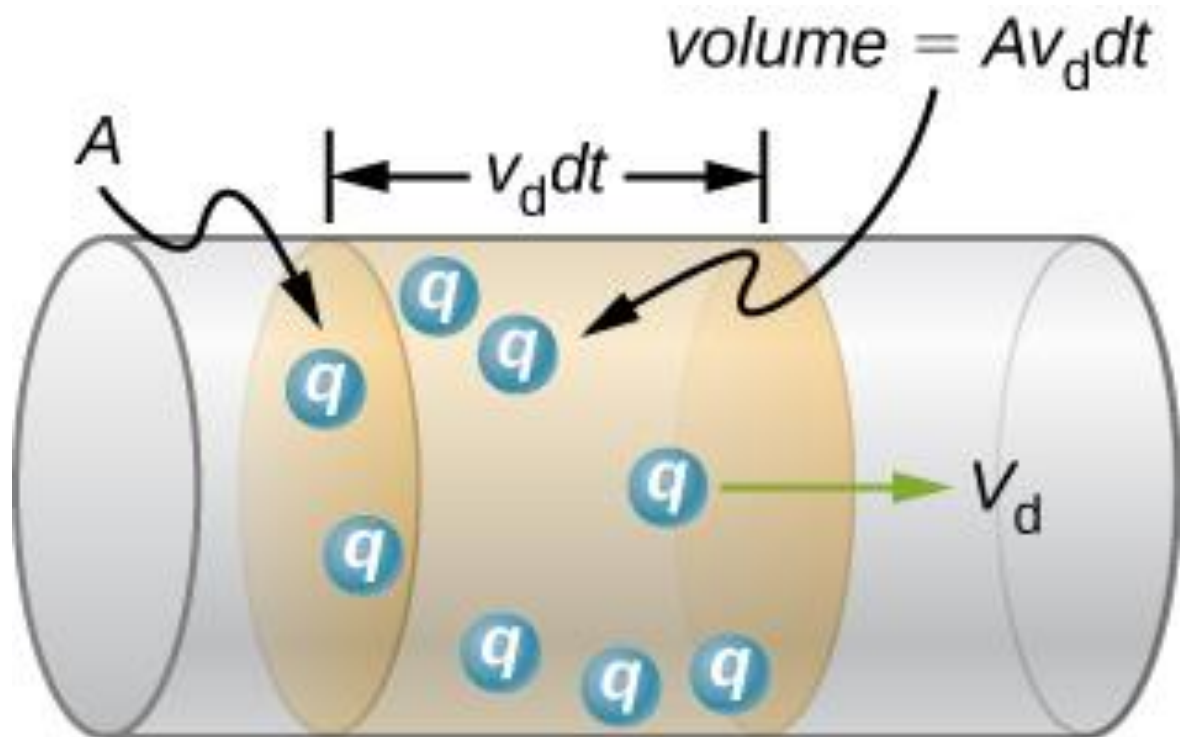

All the charges in the shaded volume of this wire move out in a time  $dt$ , having a drift velocity of magnitude  $v_d$ .

## FIGURE 9.11



A device for measuring the gauge of electrical wire. As you can see, higher gauge numbers indicate thinner wires.

## FIGURE 9.12

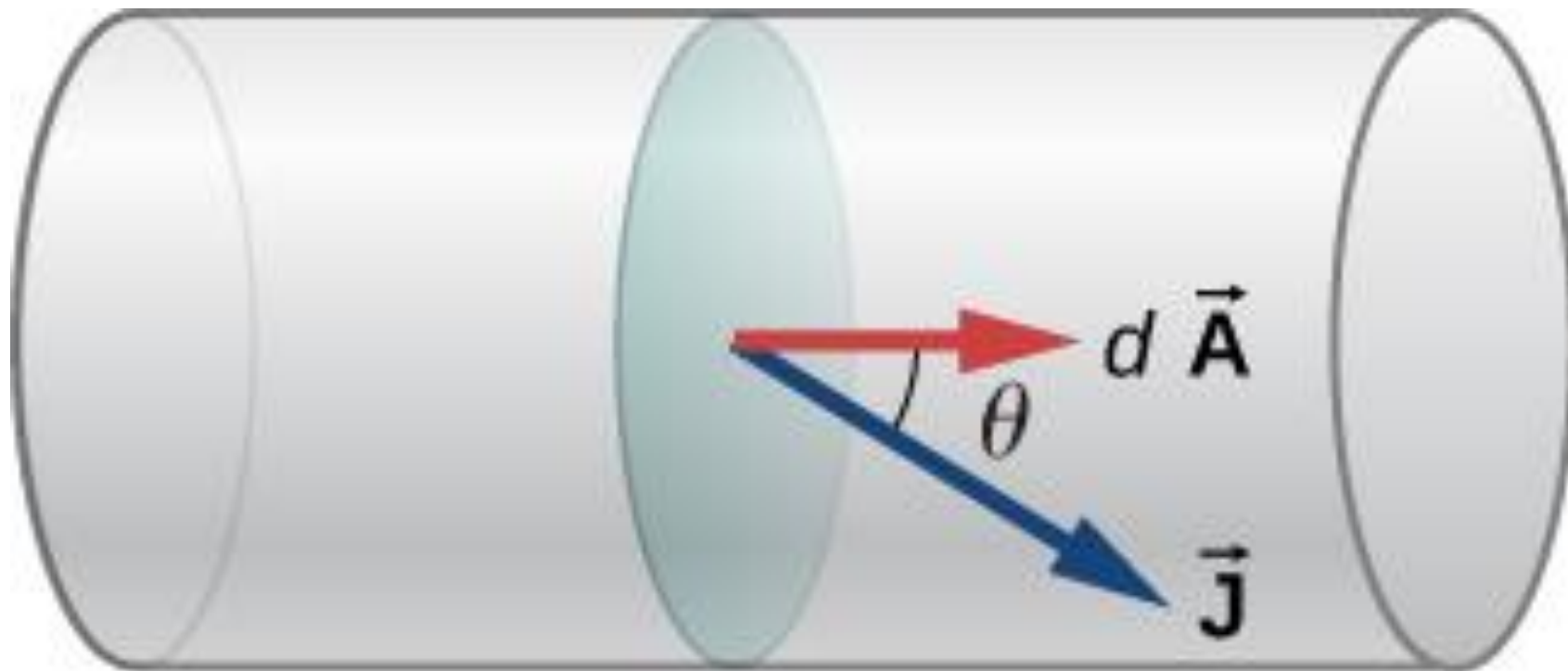

The current density  $\vec{J}$  is defined as the current passing through an infinitesimal cross-sectional area divided by the area. The direction of the current density is the direction of the net flow of positive charges and the magnitude is equal to the current divided by the infinitesimal area.

**FIGURE 9.13**

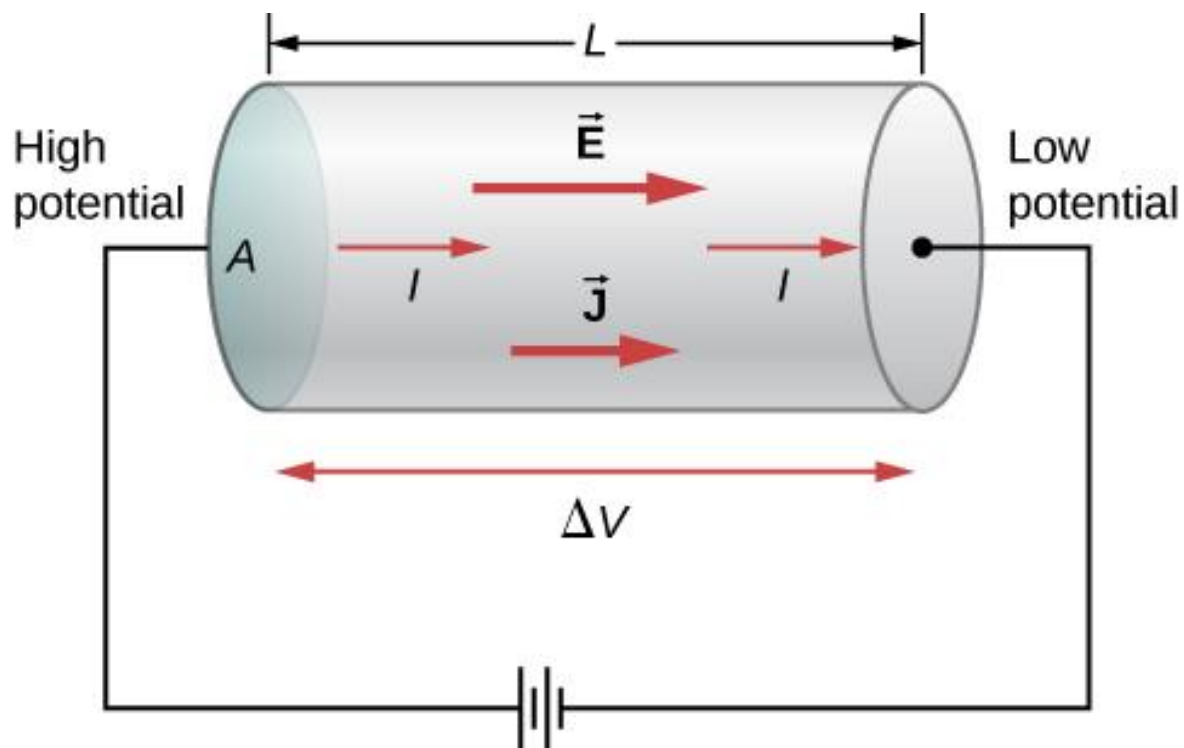

A potential provided by a battery is applied to a segment of a conductor with a cross-sectional area  $A$  and a length  $L$ .

## FIGURE 9.14



American National  
Standards Institute (ANSI)

(a)



International Electrotechnical  
Commission (IEC)

(b)

Symbols for a resistor used in circuit diagrams. (a) The ANSI symbol; (b) the IEC symbol.

## FIGURE 9.15

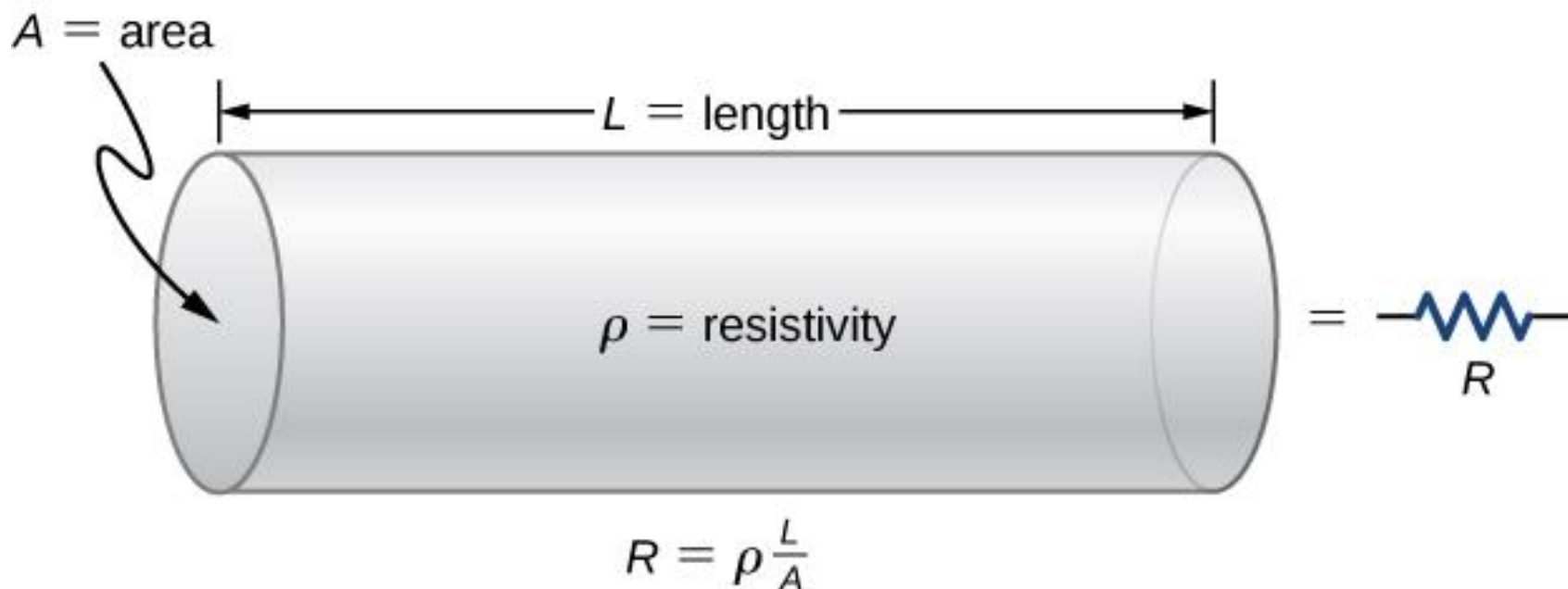

A model of a resistor as a uniform cylinder of length  $L$  and cross-sectional area  $A$ . Its resistance to the flow of current is analogous to the resistance posed by a pipe to fluid flow. The longer the cylinder, the greater its resistance. The larger its cross-sectional area  $A$ , the smaller its resistance.



# FIGURE 9.16

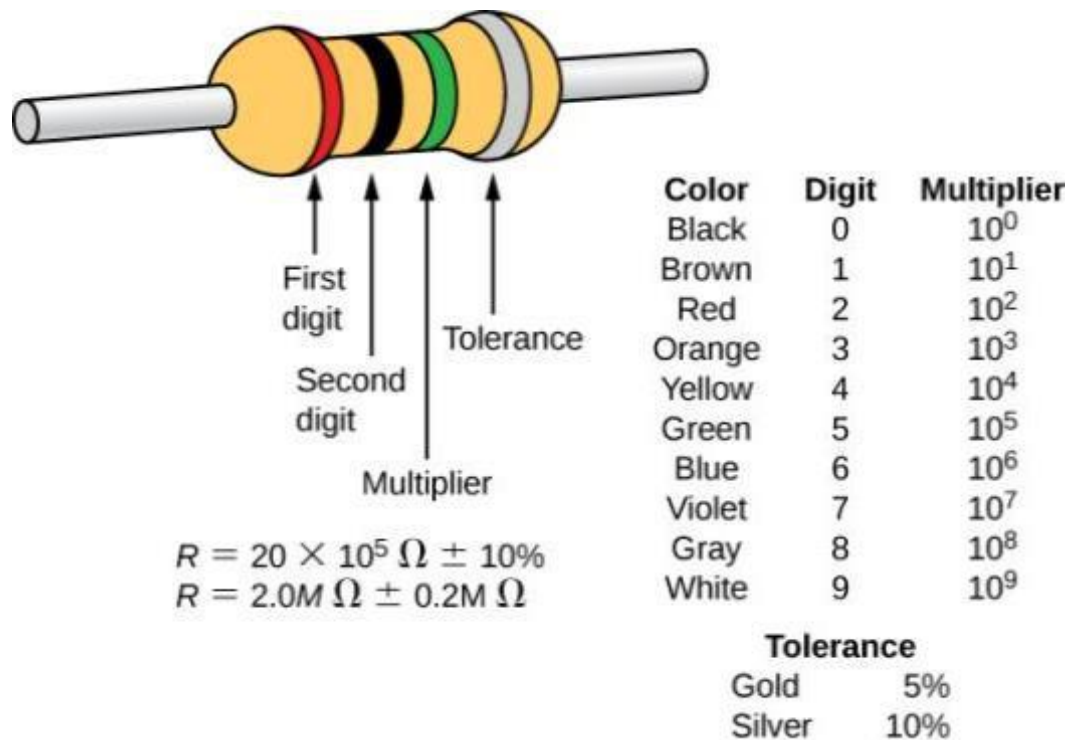

Many resistors resemble the figure shown above. The four bands are used to identify the resistor. The first two colored bands represent the first two digits of the resistance of the resistor. The third color is the multiplier. The fourth color represents the tolerance of the resistor. The resistor shown has a resistance of  $20 \times 10^5 \Omega \pm 10\%$ .

## FIGURE 9.17

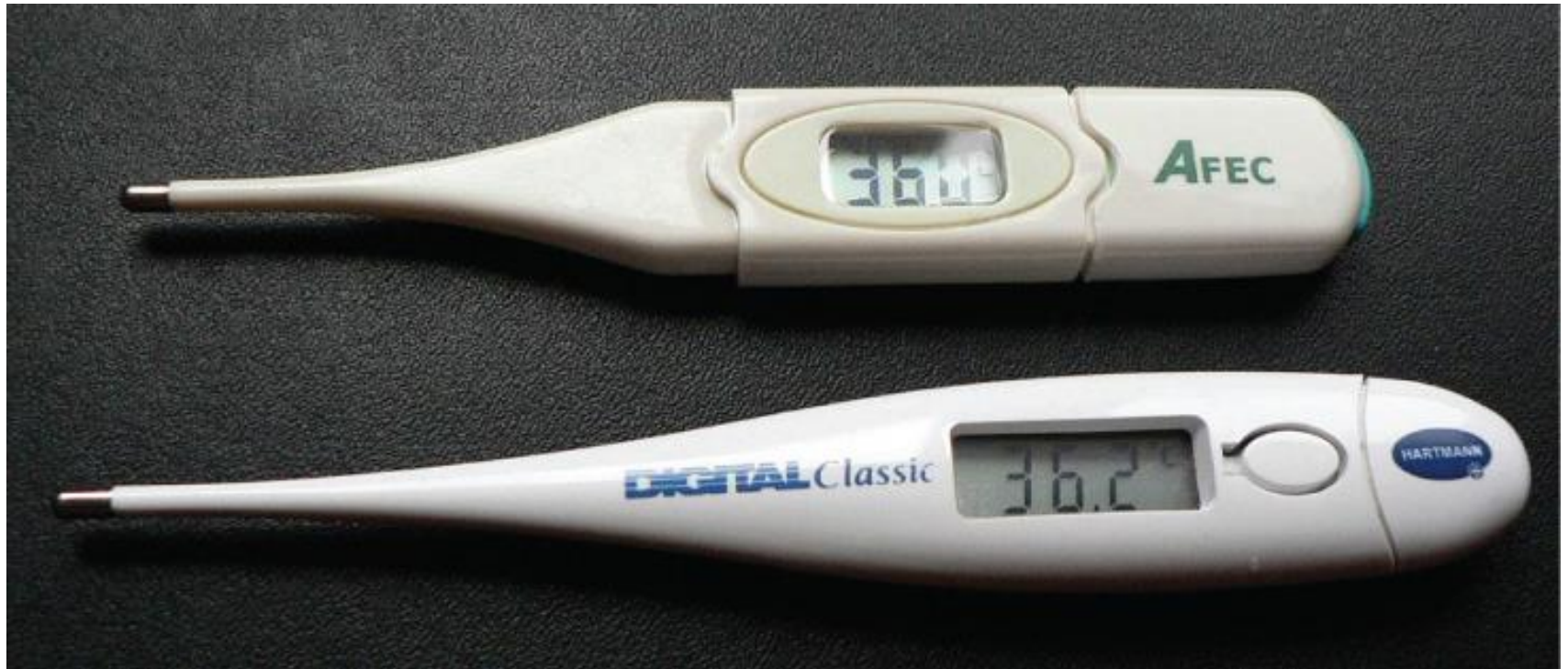

These familiar thermometers are based on the automated measurement of a thermistor's temperature-dependent resistance.

# EXERCISE 9.6

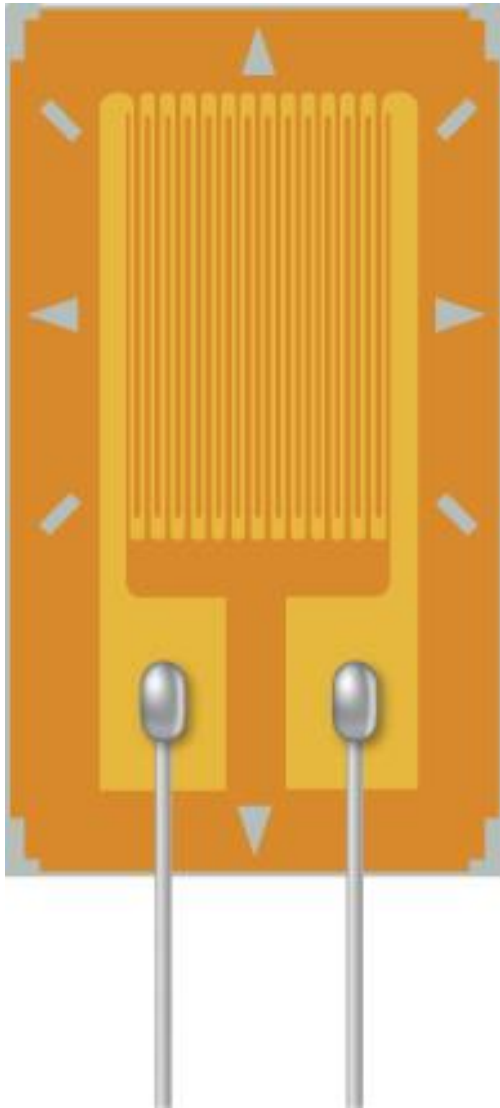

## FIGURE 9.18

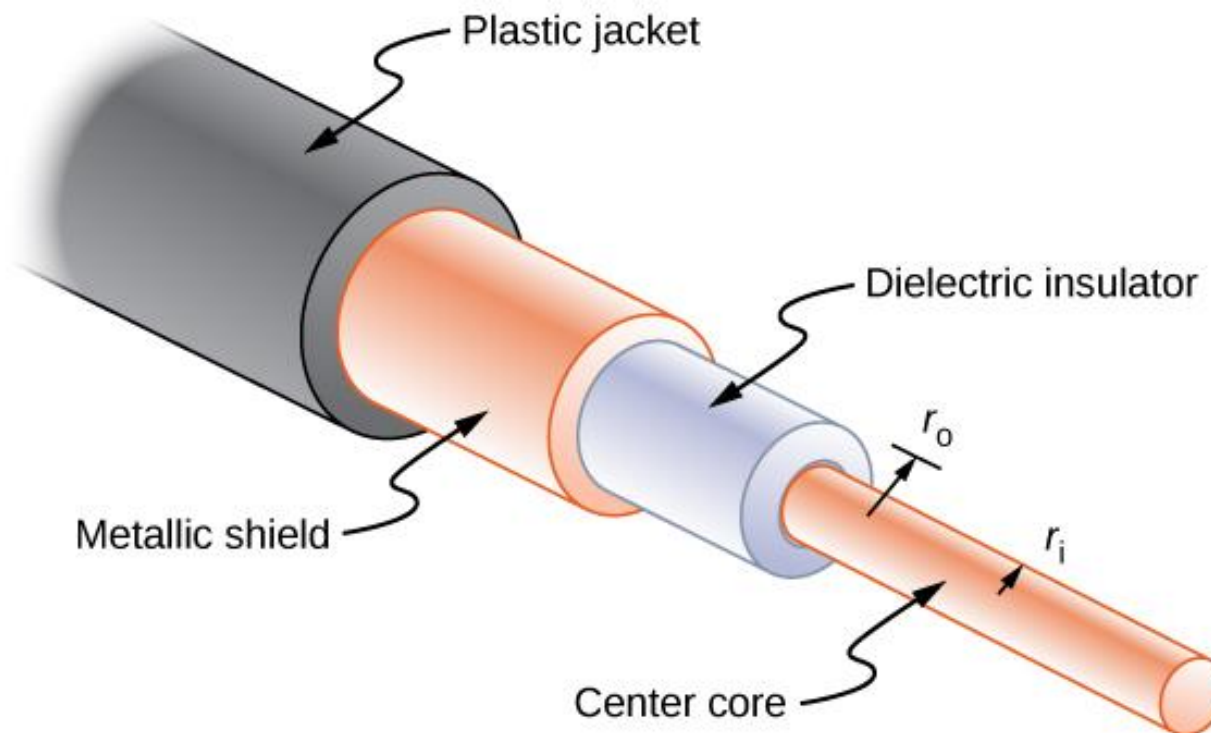

Coaxial cables consist of two concentric conductors separated by insulation. They are often used in cable TV or other audiovisual connections.

# FIGURE 9.19

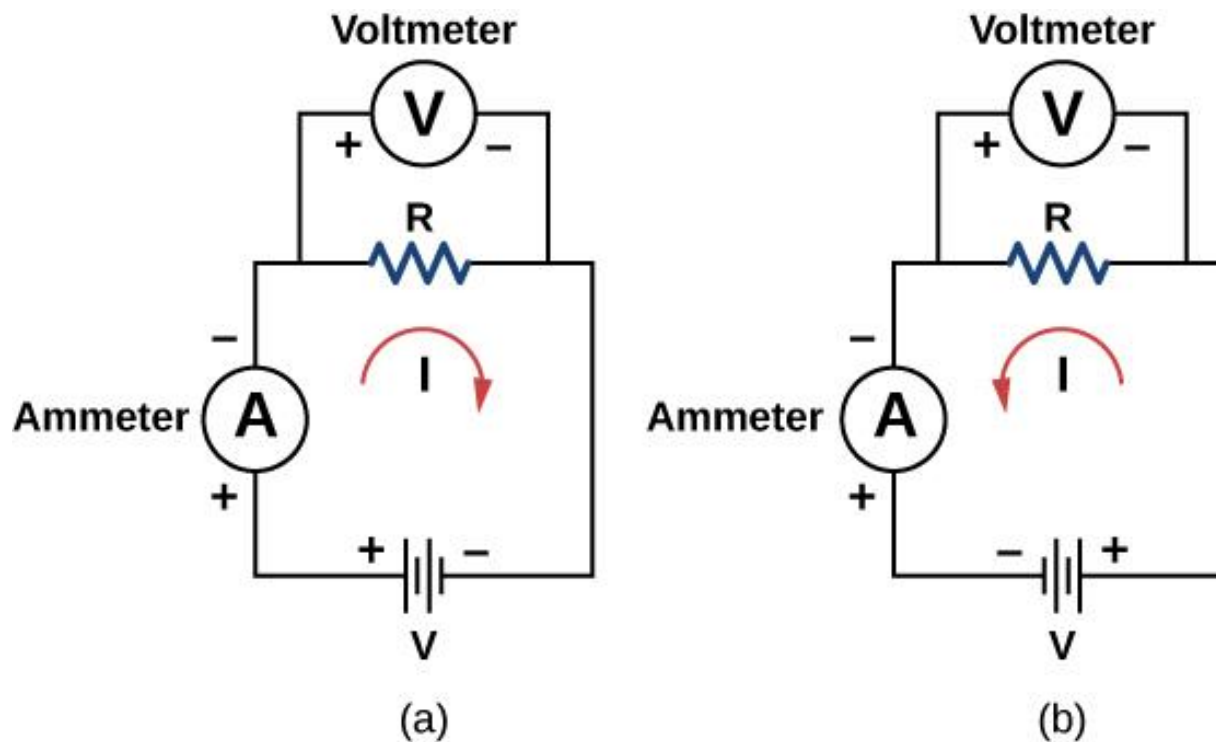

The experimental set-up used to determine if a resistor is an ohmic or nonohmic device.

- (a) When the battery is attached, the current flows in the clockwise direction and the voltmeter and ammeter have positive readings.
- (b) When the leads of the battery are switched, the current flows in the counterclockwise direction and the voltmeter and ammeter have negative readings.

# FIGURE 9.20

| I(A)  | V(V)   |
|-------|--------|
| -2.74 | -10.00 |
| -2.25 | -9.00  |
| -2.00 | -8.00  |
| -1.75 | -7.00  |
| -1.50 | -6.00  |
| -1.49 | -5.00  |
| -1.00 | -4.00  |
| -0.51 | -3.00  |
| -0.74 | -2.00  |
| -0.49 | -1.00  |
| +0.00 | +0.00  |
| +0.49 | +1.00  |
| +0.50 | +2.00  |
| +0.99 | +3.00  |
| +0.76 | +4.00  |
| +1.01 | +5.00  |
| +1.74 | +6.00  |
| +1.75 | +7.00  |
| +2.00 | +8.00  |
| +2.49 | +9.00  |
| +2.50 | +10.00 |

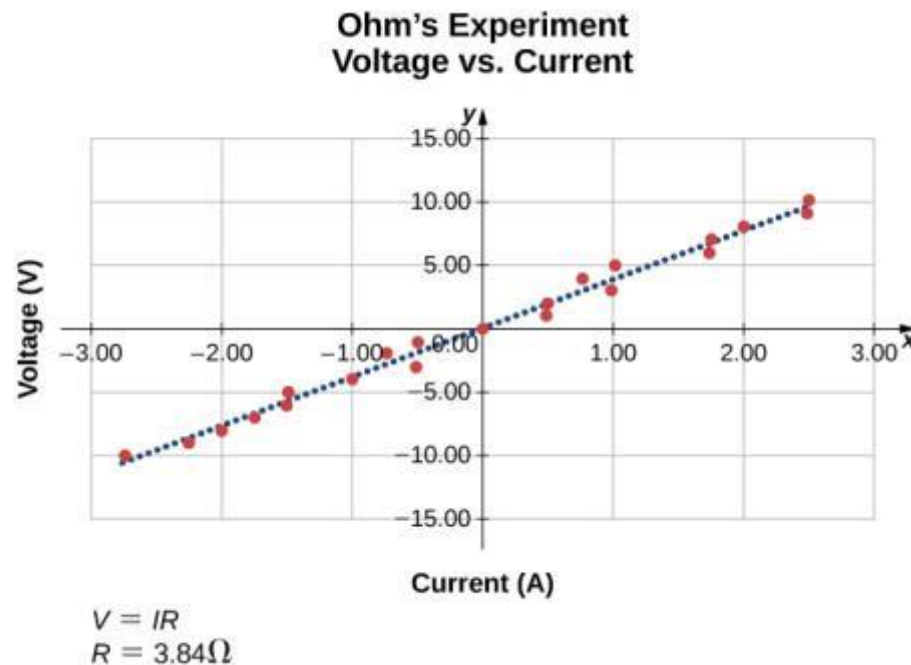

A resistor is placed in a circuit with a battery. The voltage applied varies from  $-10.00\text{ V}$  to  $+10.00\text{ V}$ , increased by  $1.00\text{-V}$  increments. A plot shows values of the voltage versus the current typical of what a casual experimenter might find.

## FIGURE 9.21

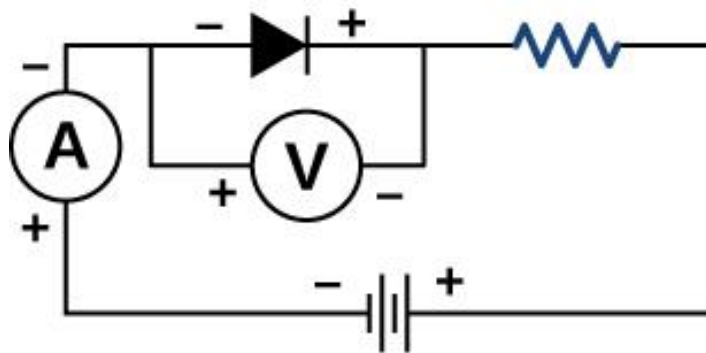
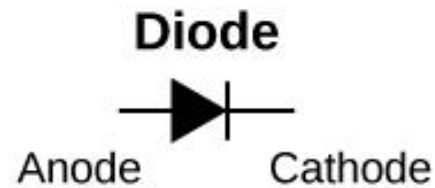

(a) Reverse bias

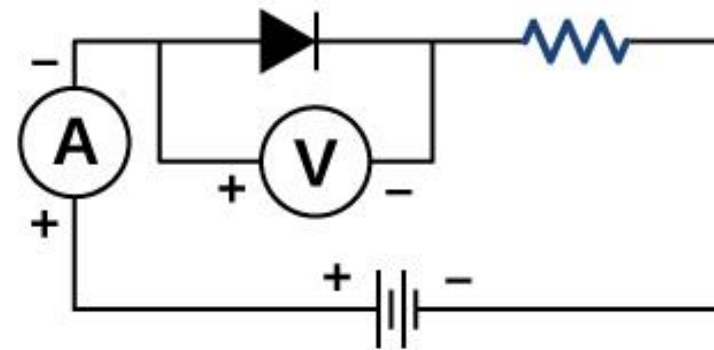

(b) Forward bias

A diode is a semiconducting device that allows current flow only if the diode is forward biased, which means that the anode is positive and the cathode is negative.

# FIGURE 9.22

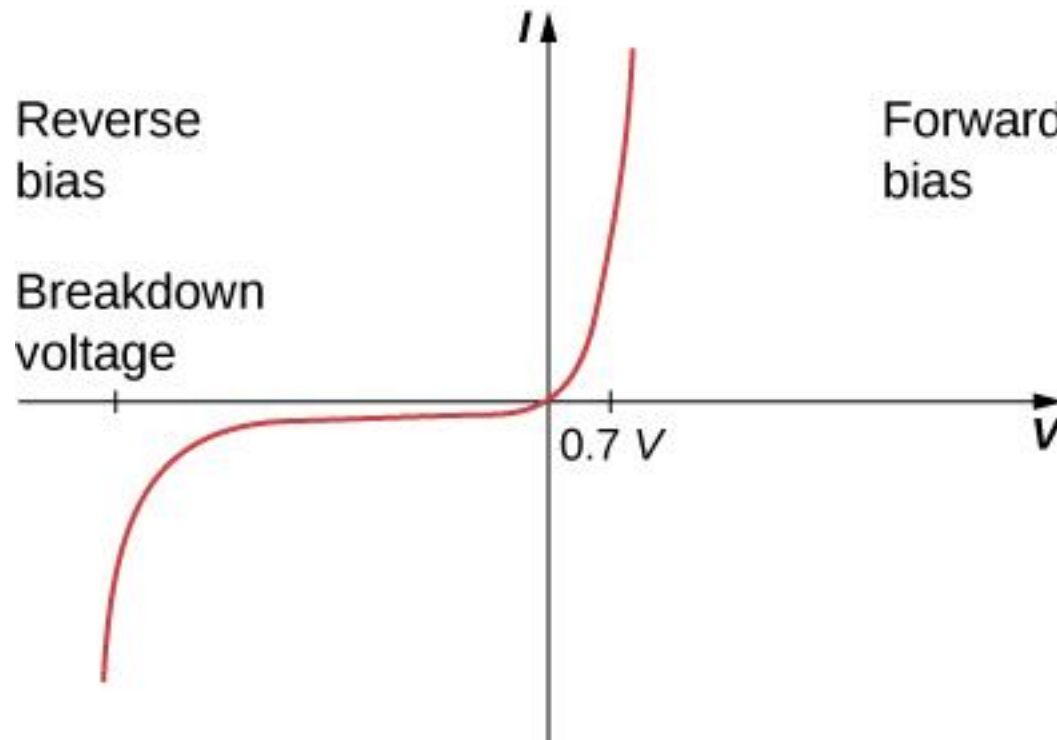

When the voltage across the diode is negative and small, there is very little current flow through the diode. As the voltage reaches the breakdown voltage, the diode conducts. When the voltage across the diode is positive and greater than 0.7 V (the actual voltage value depends on the diode), the diode conducts. As the voltage applied increases, the current through the diode increases, but the voltage across the diode remains approximately 0.7 V.



## FIGURE 9.23



(a)



(b)

- (a) Pictured above are two incandescent bulbs: a 25-W bulb (left) and a 60-W bulb (right). The 60-W bulb provides a higher intensity light than the 25-W bulb. The electrical energy supplied to the light bulbs is converted into heat and light.
- (b) This compact fluorescent light (CFL) bulb puts out the same intensity of light as the 60-W bulb, but at 1/4 to 1/10 the input power. (credit a: modification of works by “Dickbauch”/Wikimedia Commons and Greg Westfall; credit b: modification of work by “dbgg1979”/Flickr)

**FIGURE 9.24**

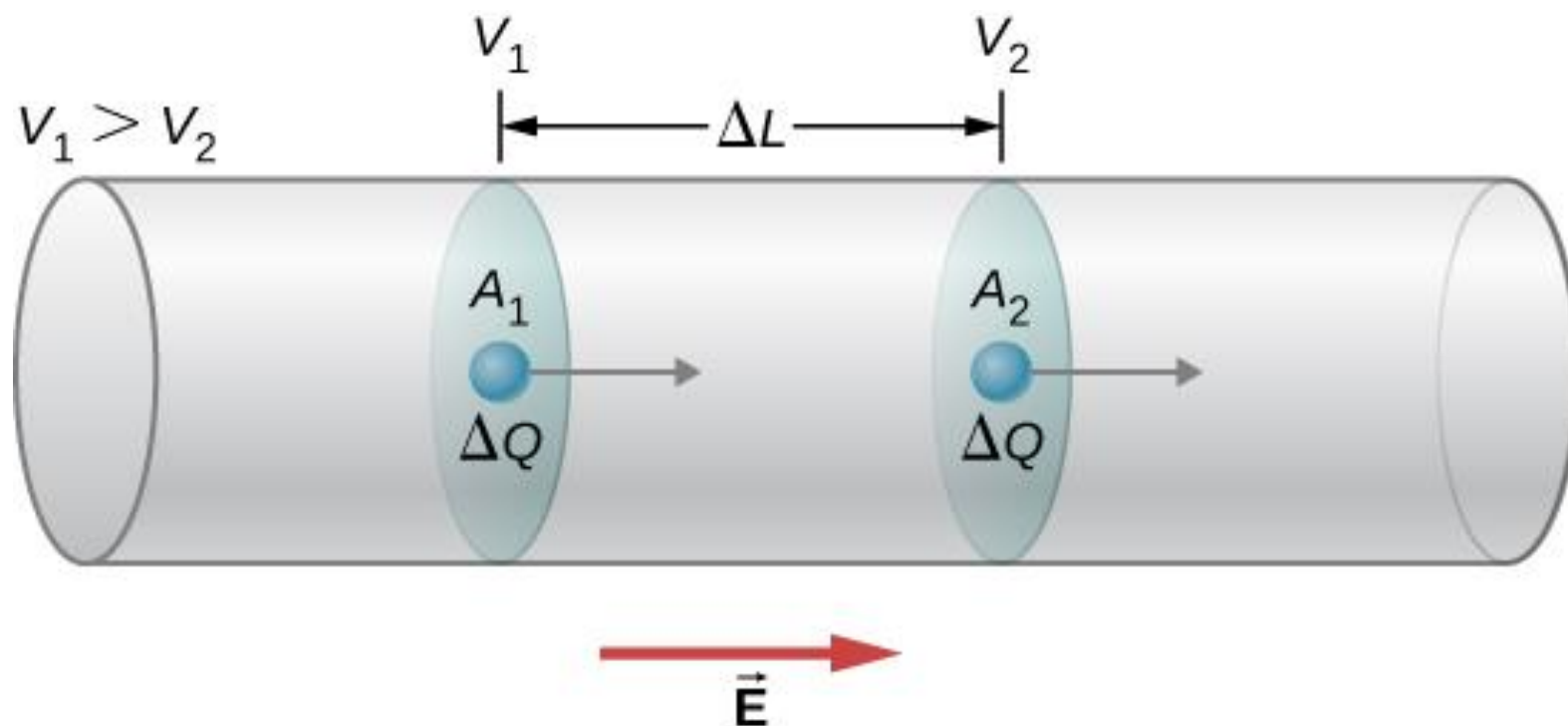

When there is a potential difference across a conductor, an electrical field is present that points in the direction from the higher potential to the lower potential.

## FIGURE 9.25



A fuse consists of a piece of wire between two contacts. When a current passes through the wire that is greater than the rated current, the wire melts, breaking the connection. Pictured is a “blown” fuse where the wire broke protecting a circuit (credit: modification of work by “Shardayyy”/Flickr).

# FIGURE 9.26

This circle shows a summary of the equations for the relationships between power, current, voltage, and resistance.

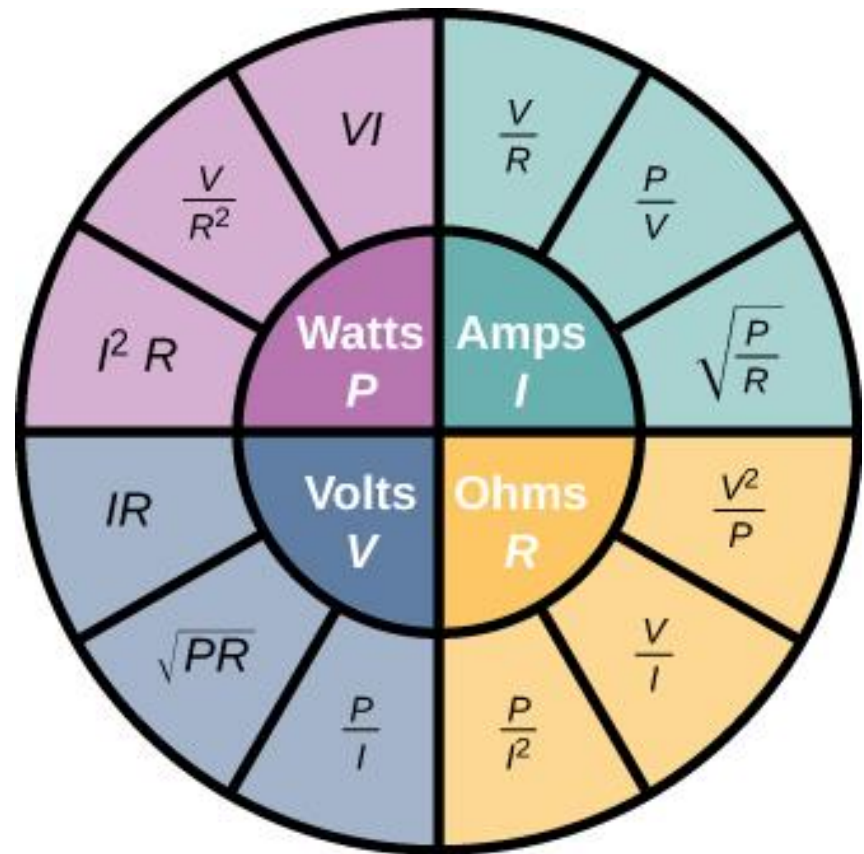

$P =$  Power

$V =$  Voltage

$I =$  Current

$R =$  Resistance

# FIGURE 9.27

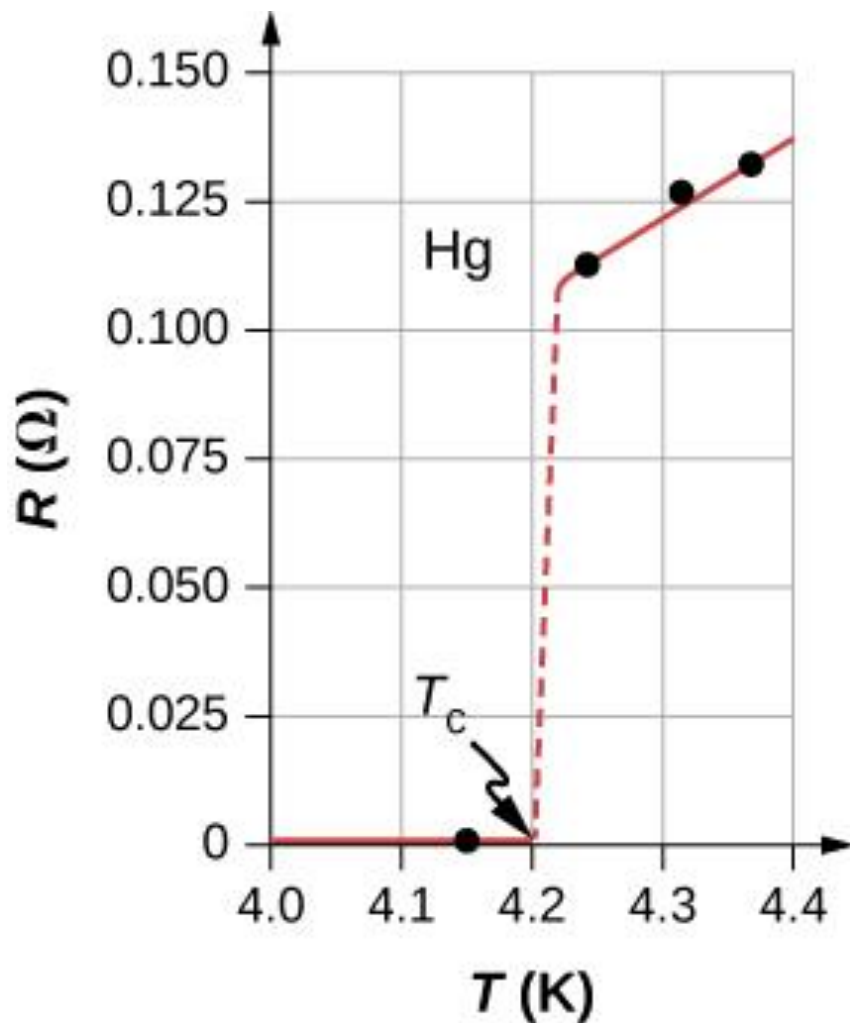

The resistance of a sample of mercury is zero at very low temperatures—it is a superconductor up to the temperature of about 4.2 K. Above that critical temperature, its resistance makes a sudden jump and then increases nearly linearly with temperature.

## FIGURE 9.28

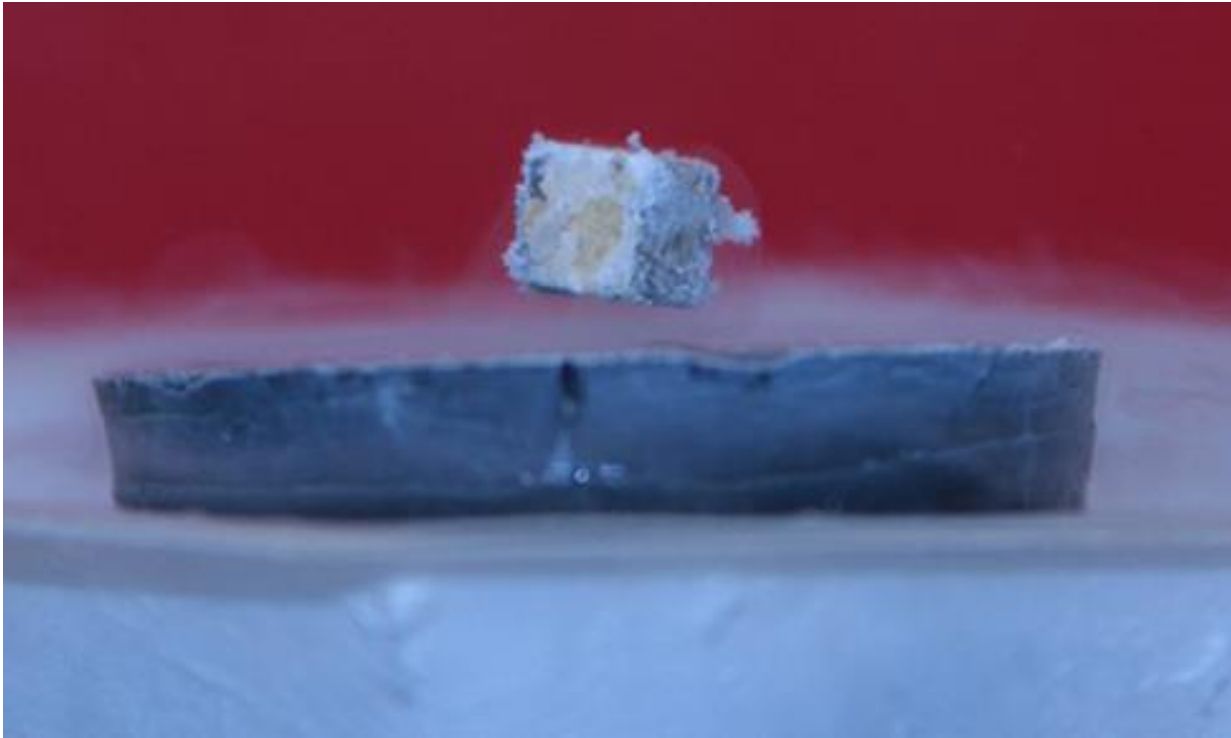

A small, strong magnet levitates over a superconductor cooled to liquid nitrogen temperature. The magnet levitates because the superconductor excludes magnetic fields.

## FIGURE 9.29

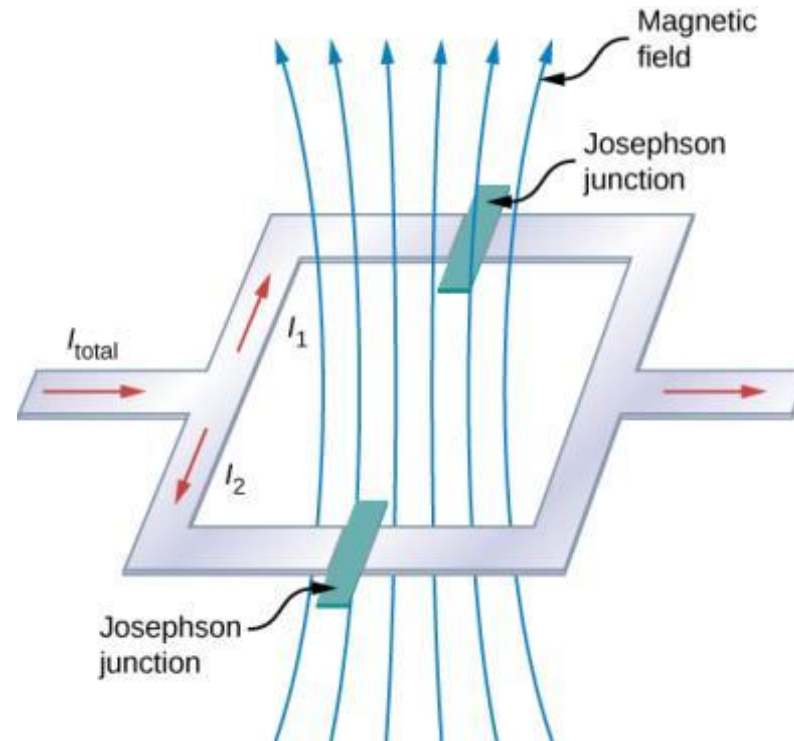

The SQUID (superconducting quantum interference device) uses a superconducting current loop and two Josephson junctions to detect magnetic fields as low as  $10^{-14}$  T (Earth's magnet field is on the order of  $0.3 \times 10^{-5}$  T).

# EXERCISE 10

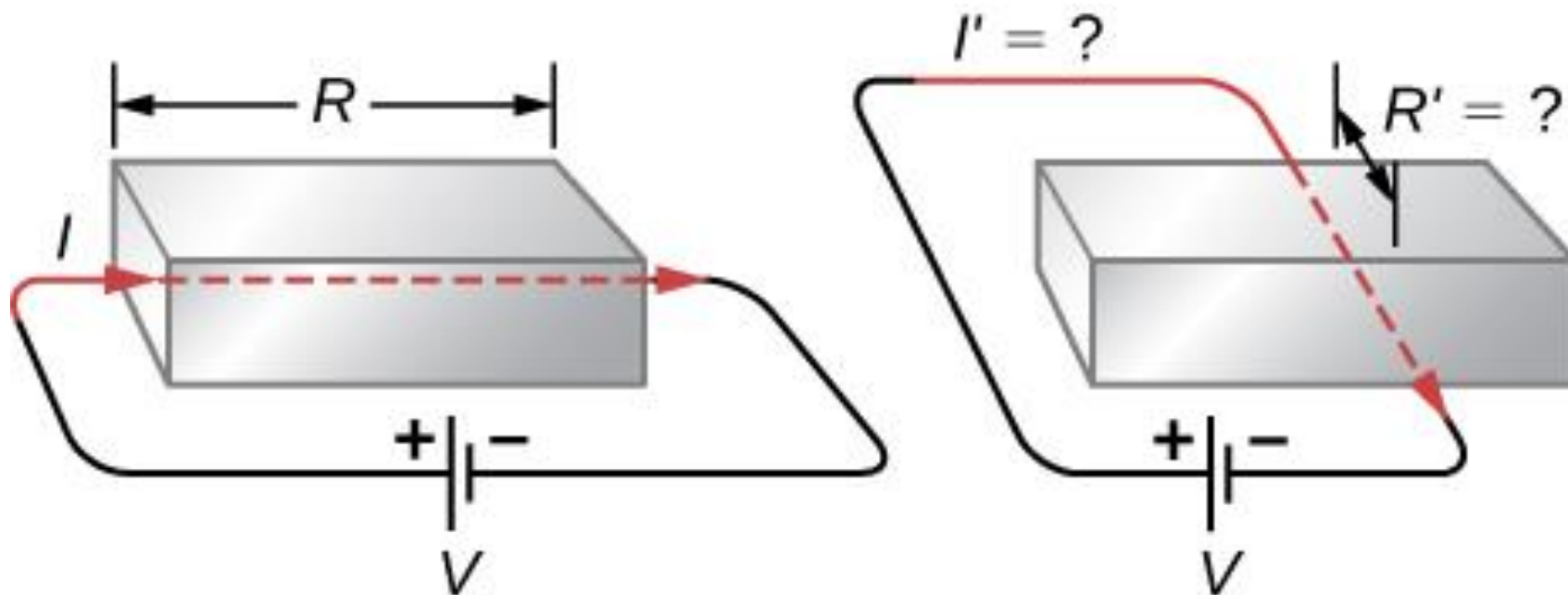



# EXERCISE 13

## Current vs. Voltage

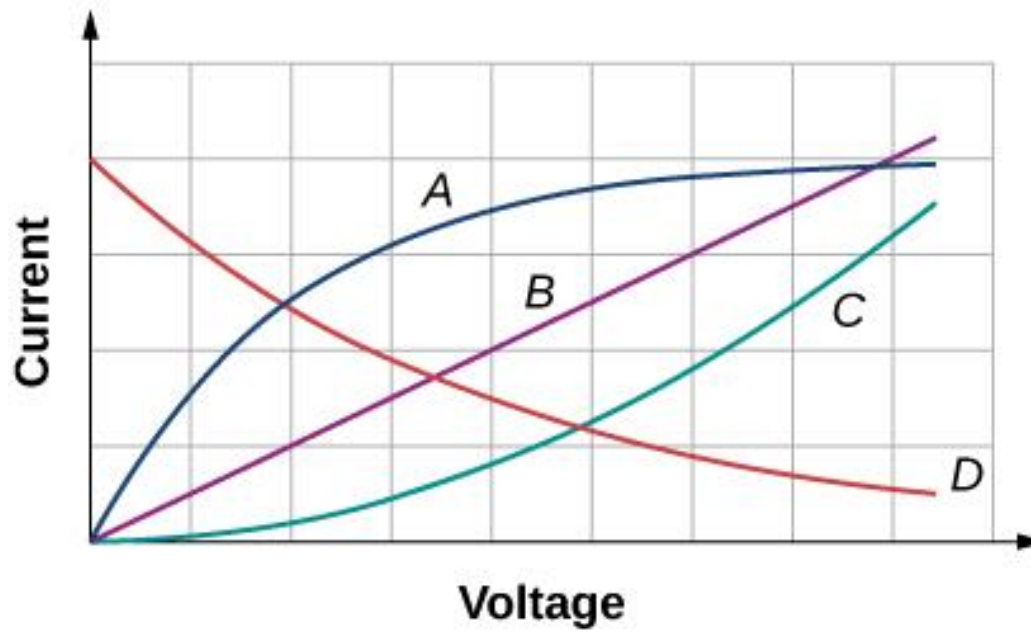

# EXERCISE 53

## Ohm's Law

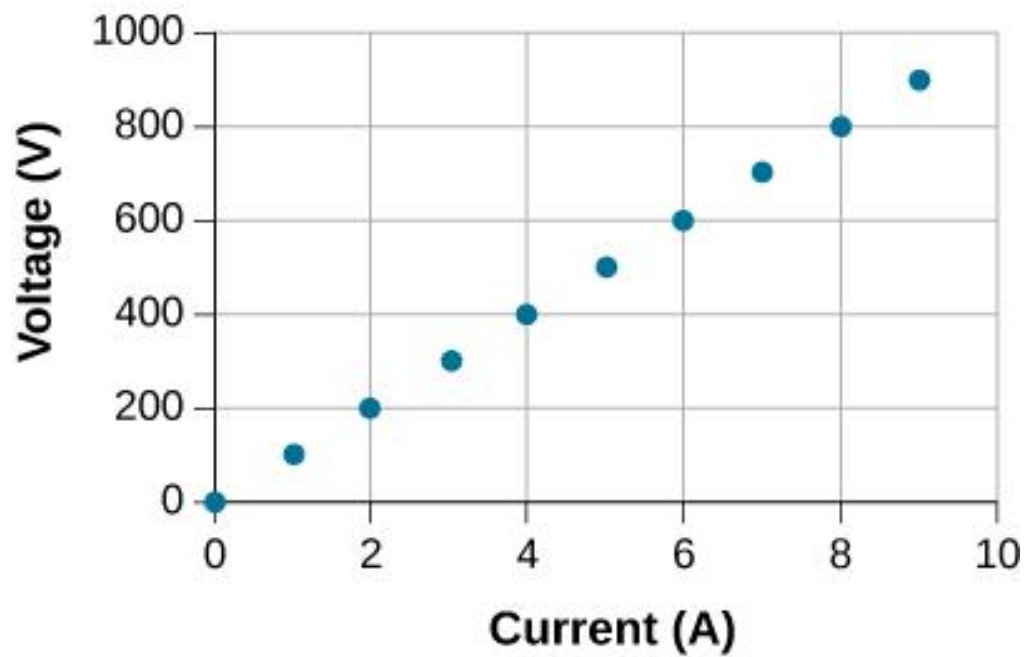

## EXERCISE 86

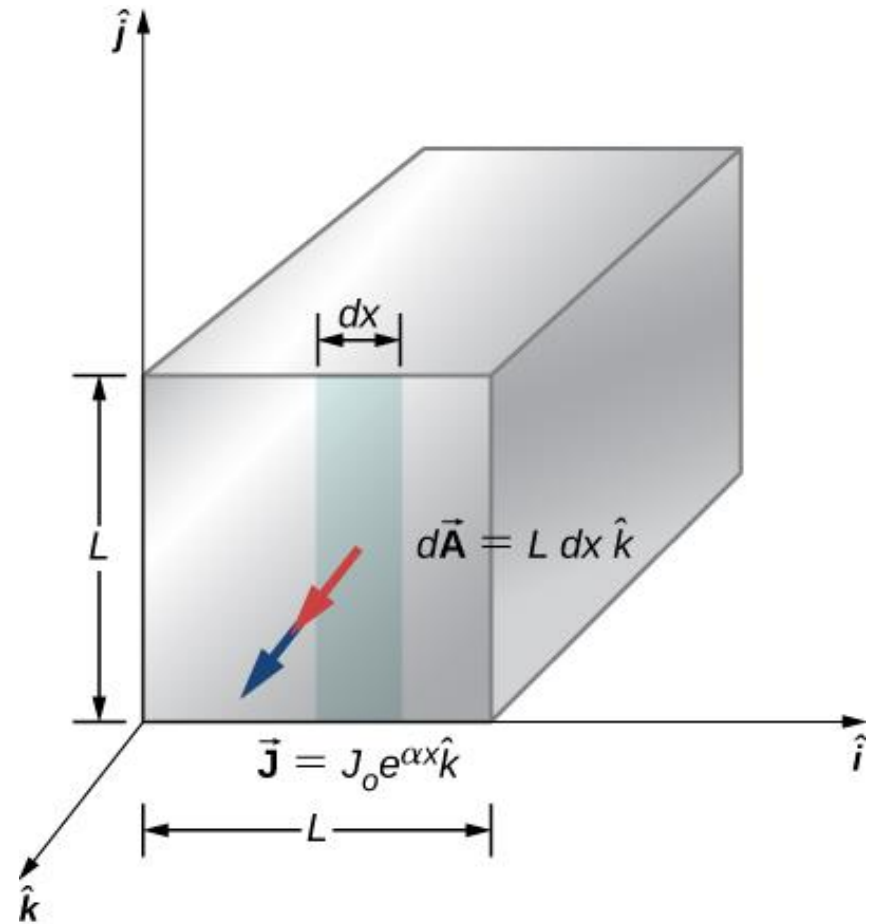

## EXERCISE 89

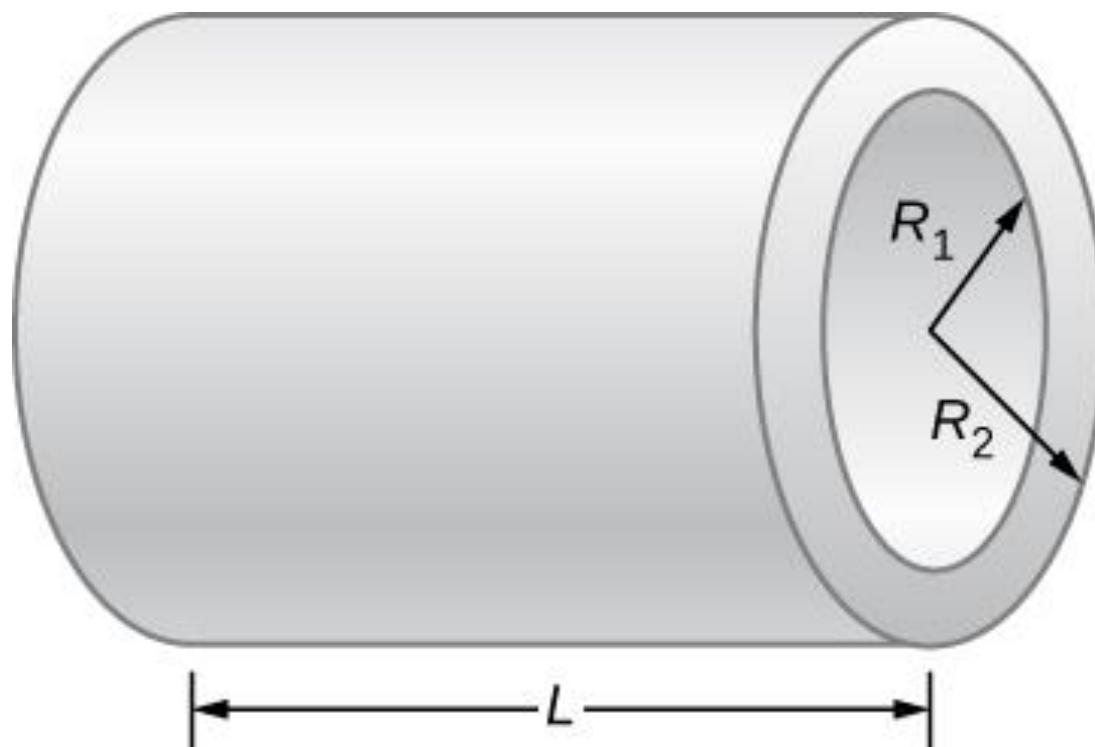



This OpenStax ancillary resource is © Rice University under a CC-BY 4.0 International license; it may be reproduced or modified but must be attributed to OpenStax, Rice University and any changes must be noted.