

COMPUTER AIDED ENGINEERING DESIGN (BFF2612)

ASSIGNMENT 2

by

Dr. Mohd Nizar Mhd Razali

Faculty of Manufacturing Engineering
mnizar@ump.edu.my



Computer Aided Engineering
Design: Dr Nizar

COMPUTER AIDED ENGINEERING DESIGN

BFF2612

SELF PRACTICES

SKETCHER WORKBENCH



Computer Aided Engineering
Design: Dr Nizar

INSTRUCTIONS

Select appropriate plane and draw the sketch of the model shown in **Figure A**. The sketch dimension is shown in **Figure B**. If dimensions are not shown, simply sketch in the sketcher so that the model looks similar to the figure given. Your sketch must be fully defined.



Model 1

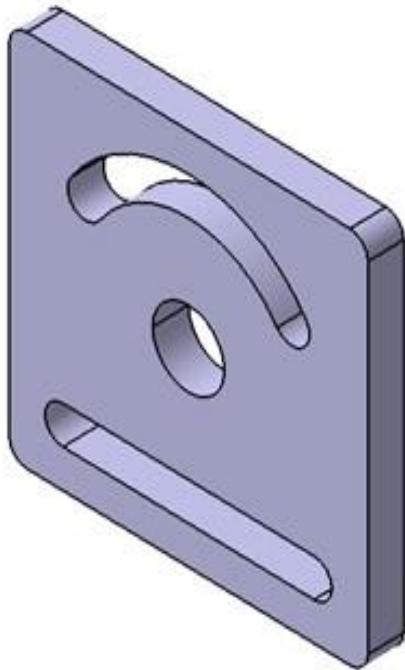

Figure A

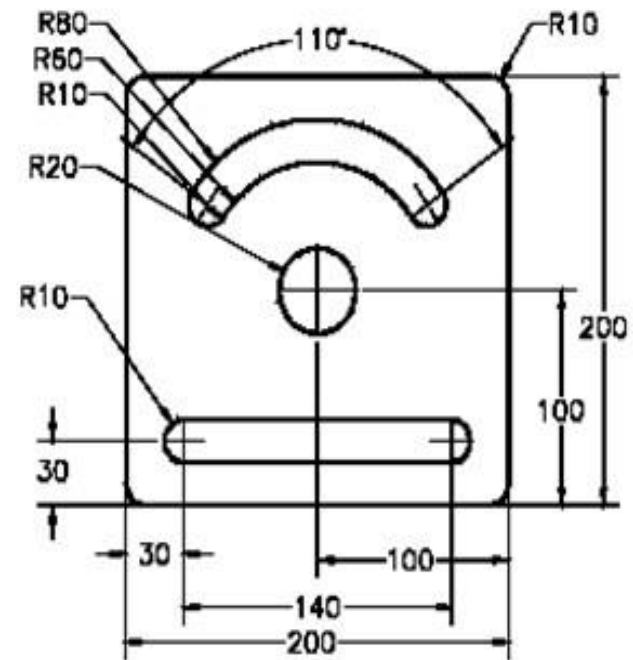

Figure B

Model 2

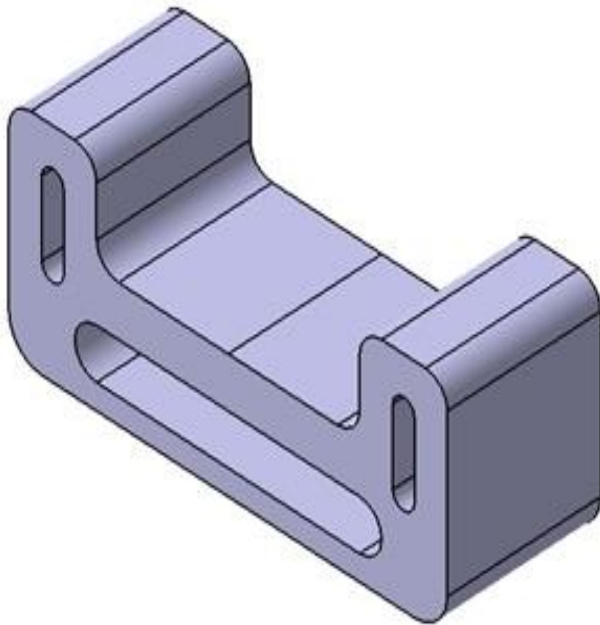

Figure A

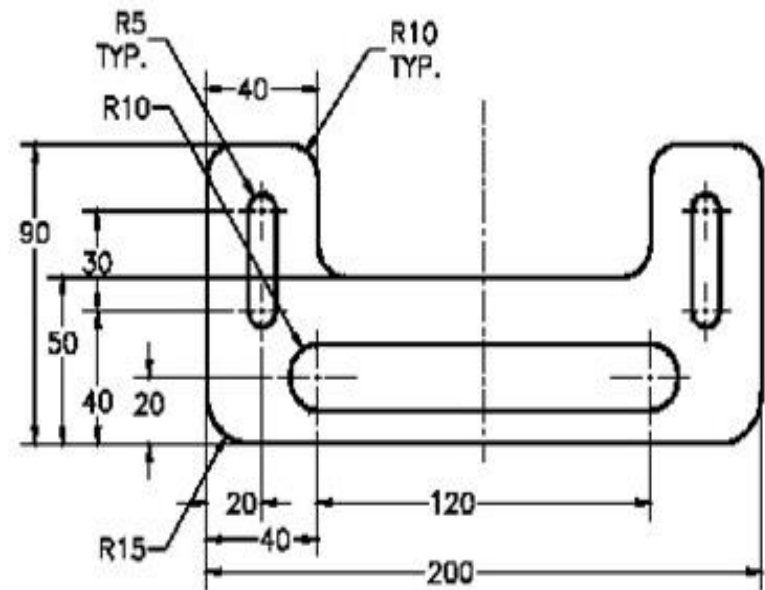

Figure B



Model 3

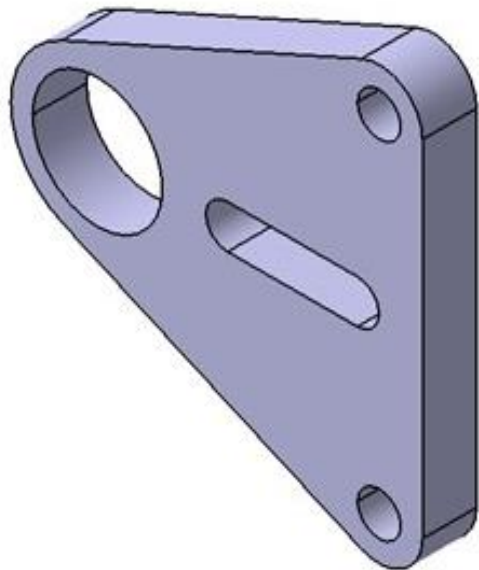

Figure A

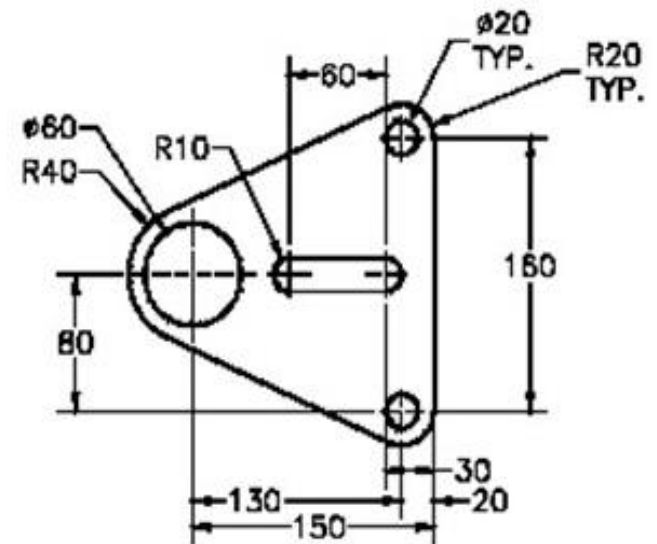

Figure B



Model 4

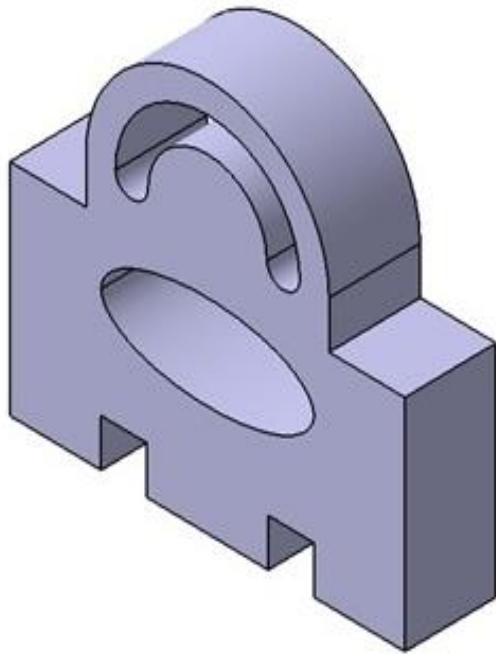

Figure A

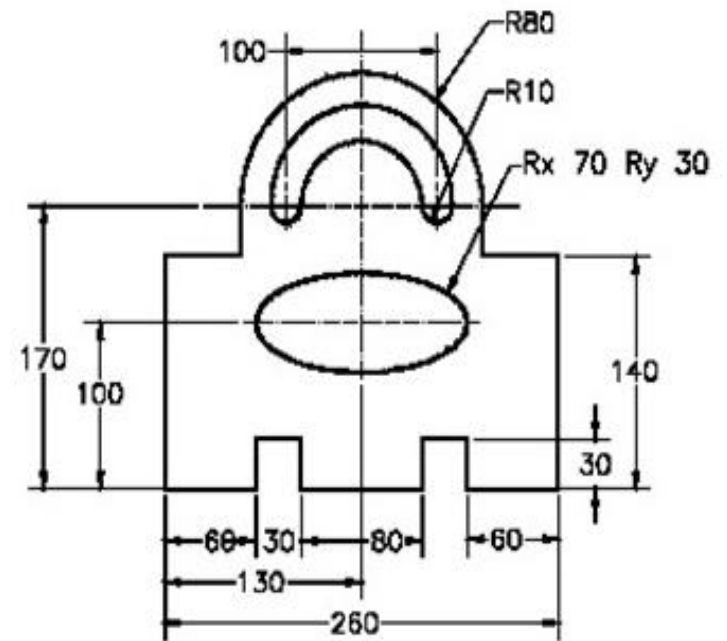

Figure B



COMPUTER AIDED ENGINEERING DESIGN (BFF2612)

Dr. Nizar



Computer Aided Engineering
Design: Dr Nizar